

ITB INNOVATION

Montages d'usinage hydrauliques

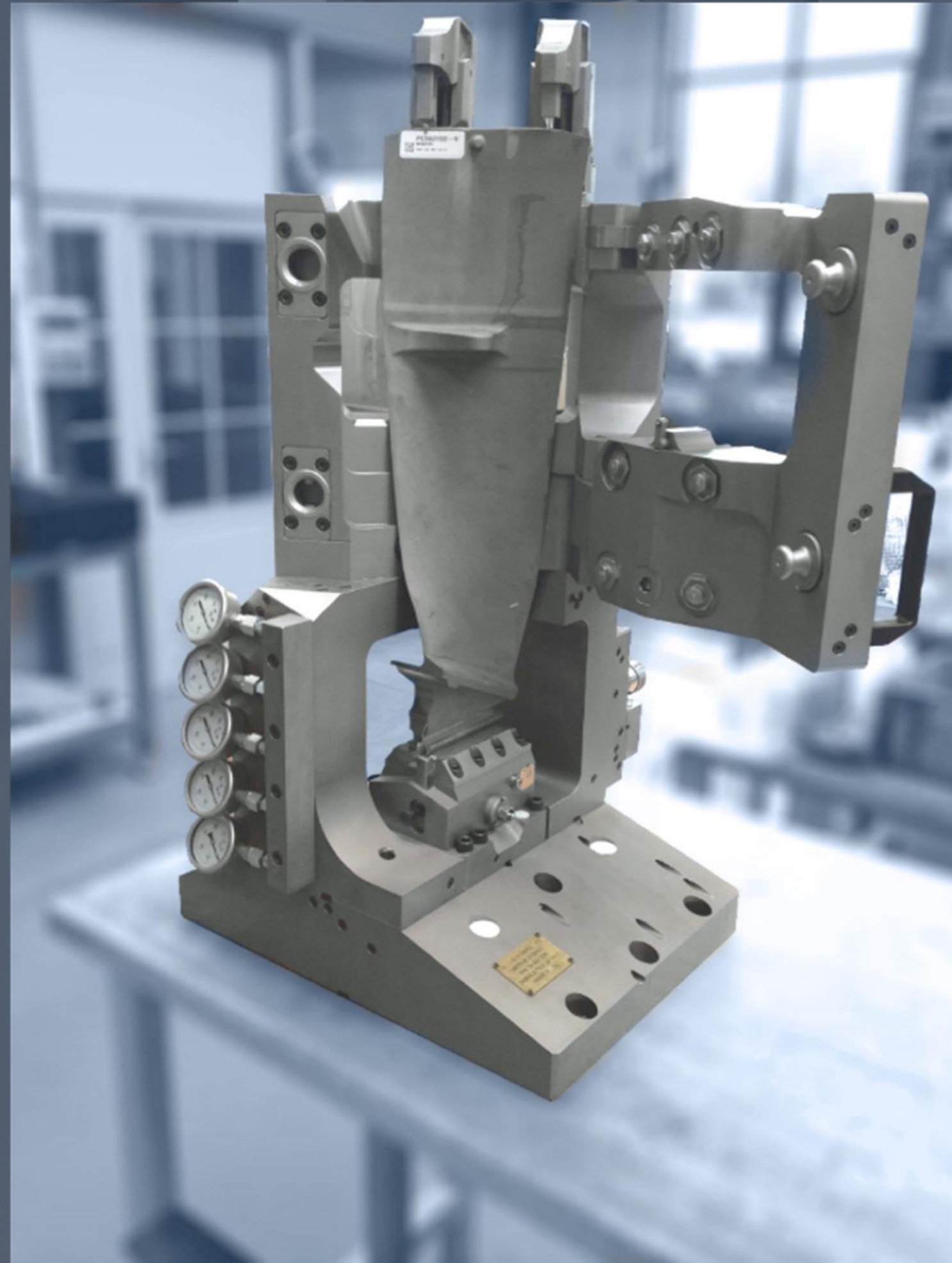

Mandrins hydrauliques spéciaux

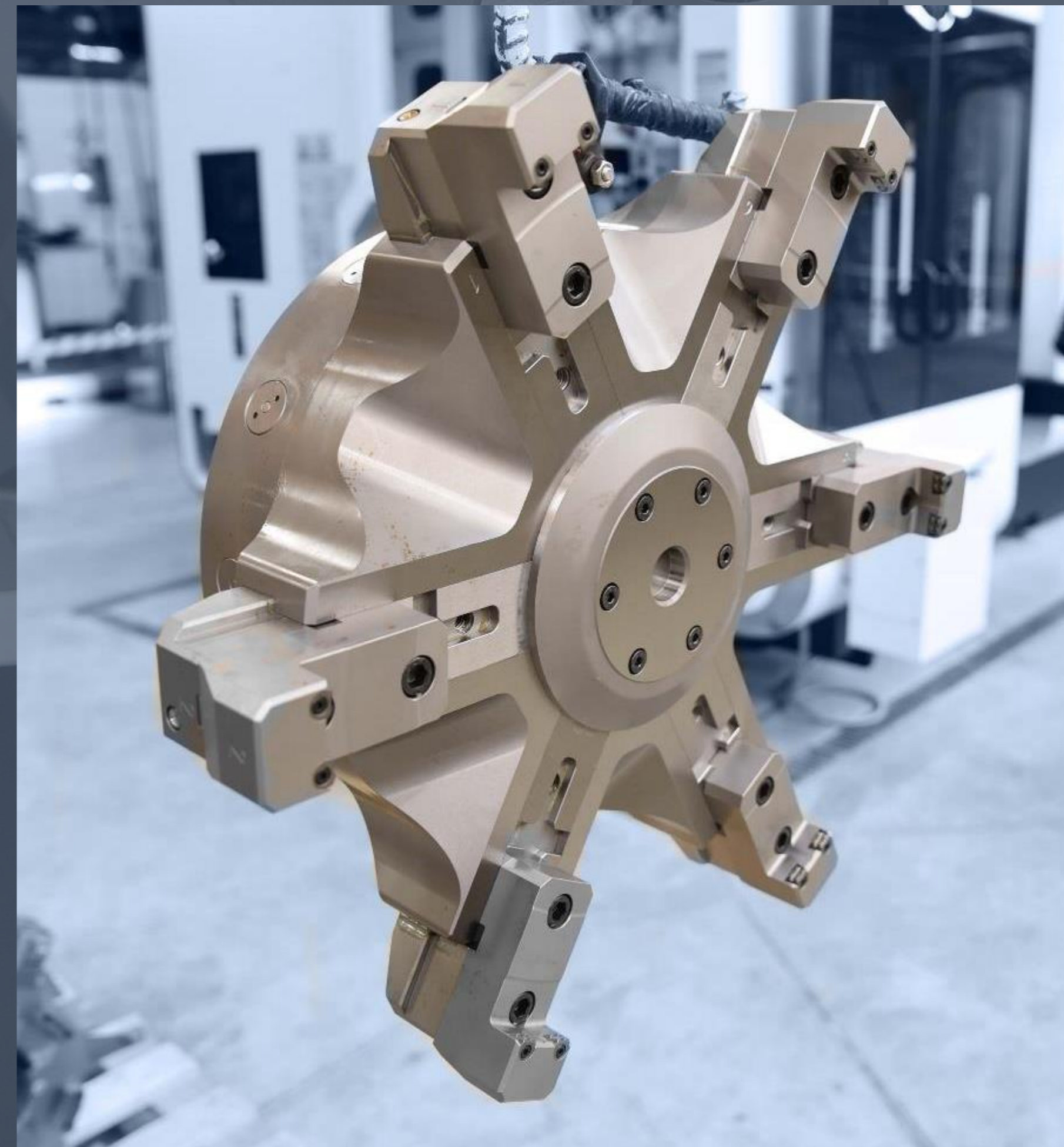

LES CHIFFRES



52
COLLABORATEURS

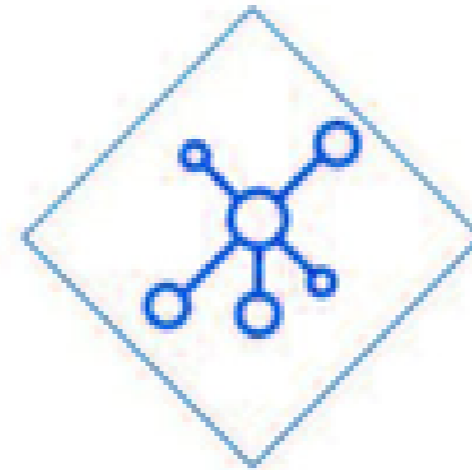

27 ANNÉES
D'EXPÉRIENCE



12 MILLIONS DE
CA



10 personnes au
bureau d'études



UN PARC DE
25 MACHINES

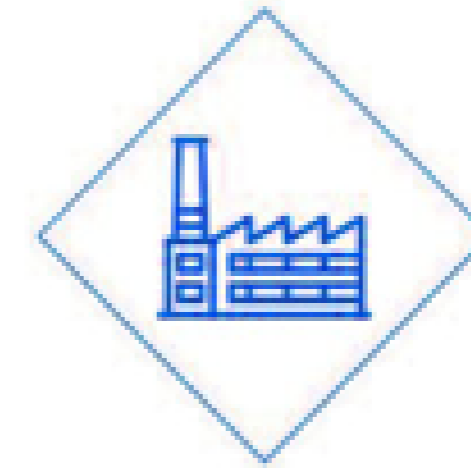

3000 m² DE
LOCAUX
COUVERT



IT+3
INNOVATION



NOS ETUDES

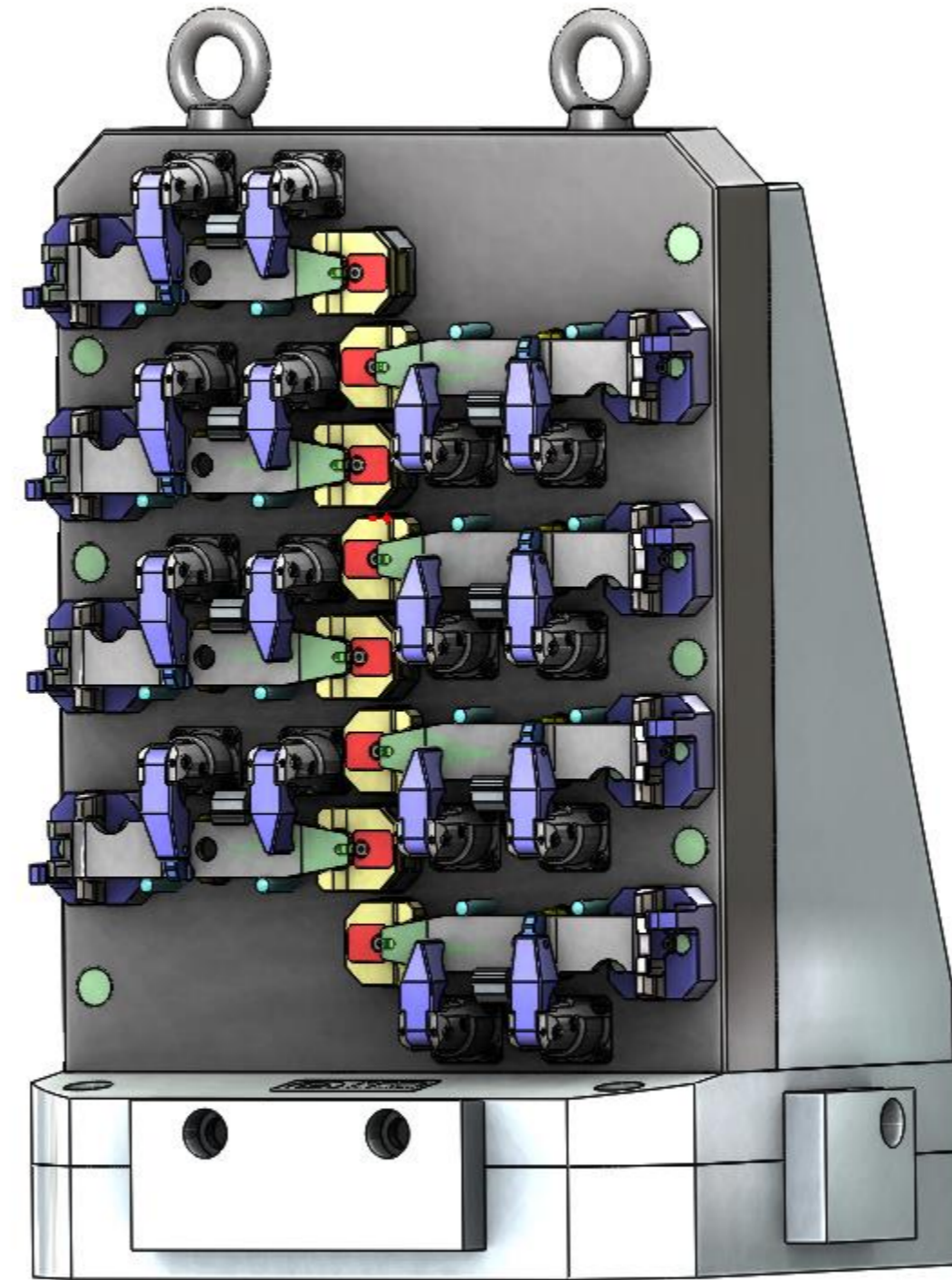
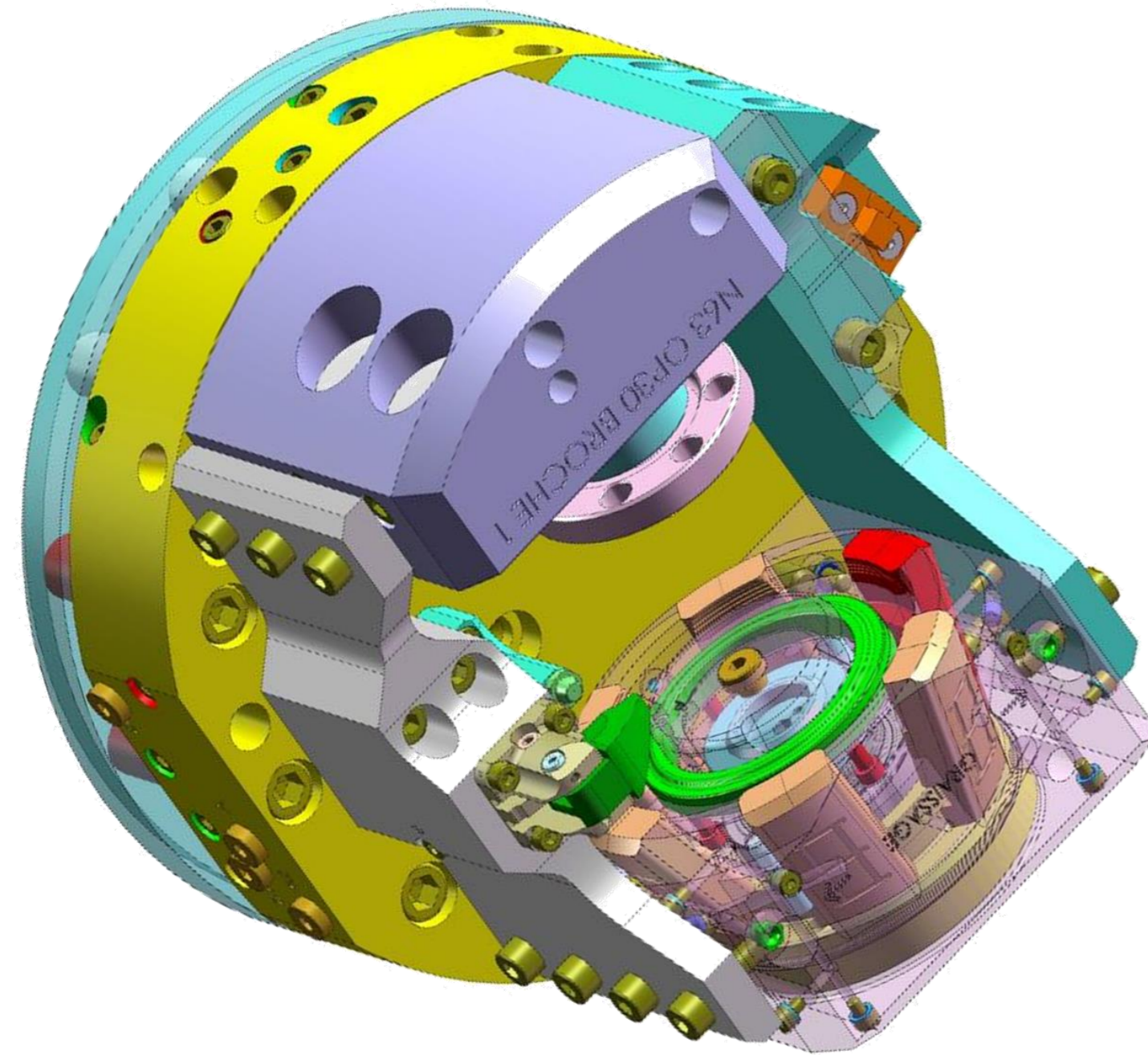

Un système breveté: LA BRIDE COMPACTE

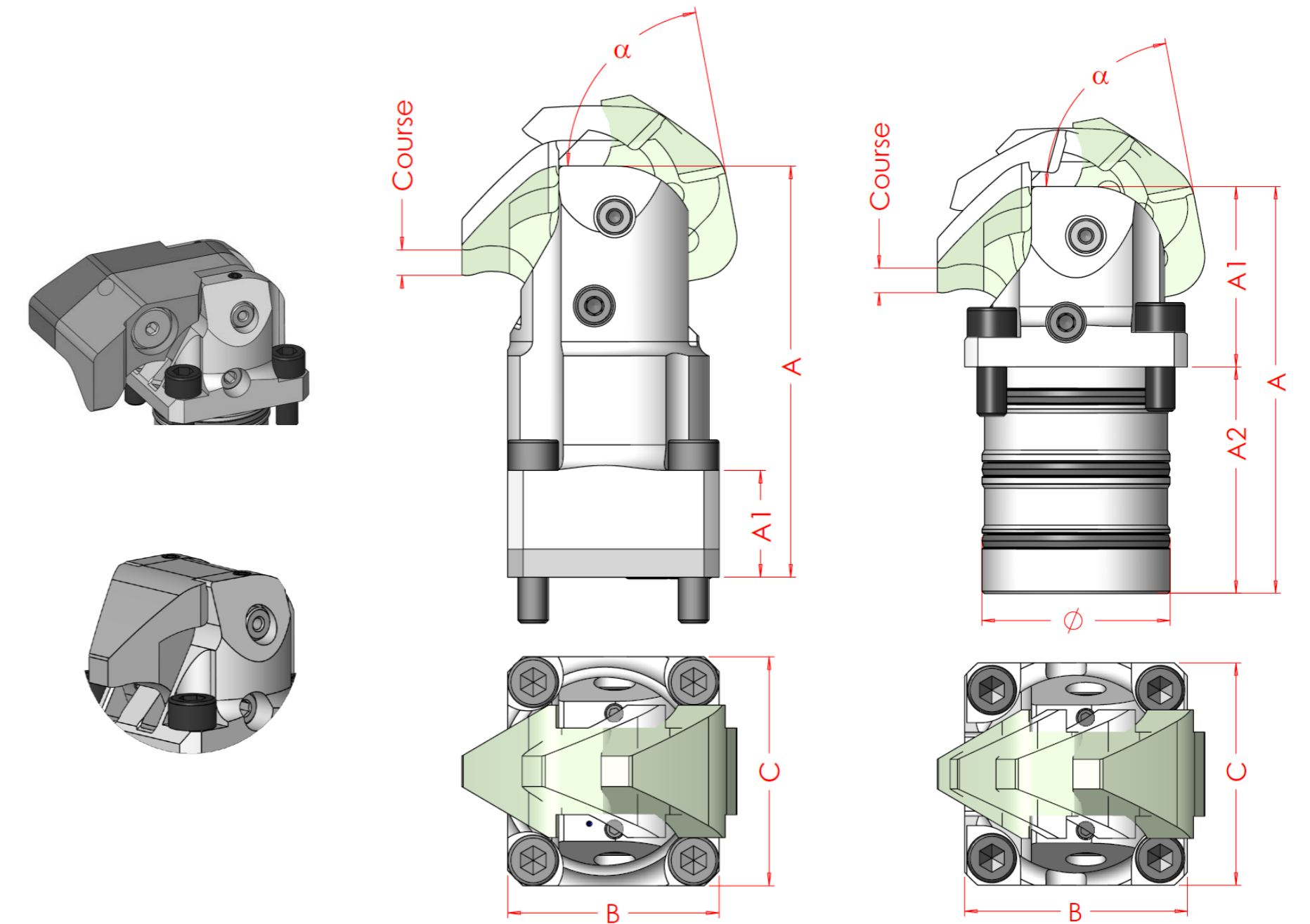

IT+3
INNOVATION



NOTRE PROCESS : L'USINAGE

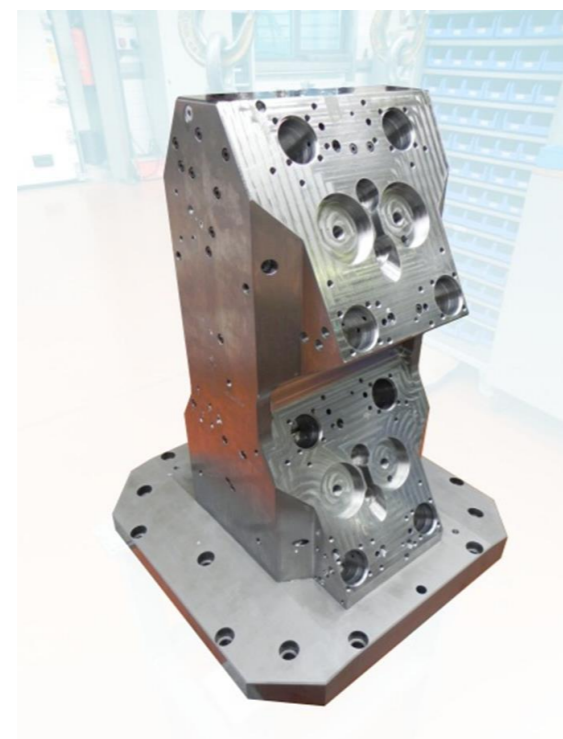
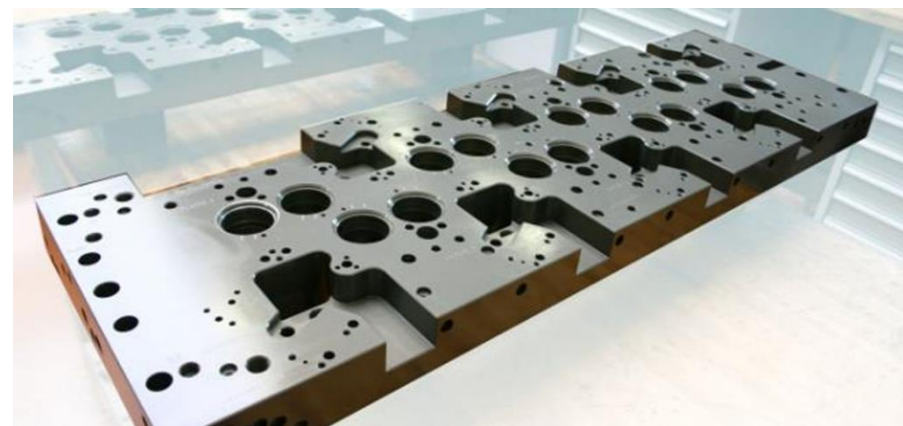
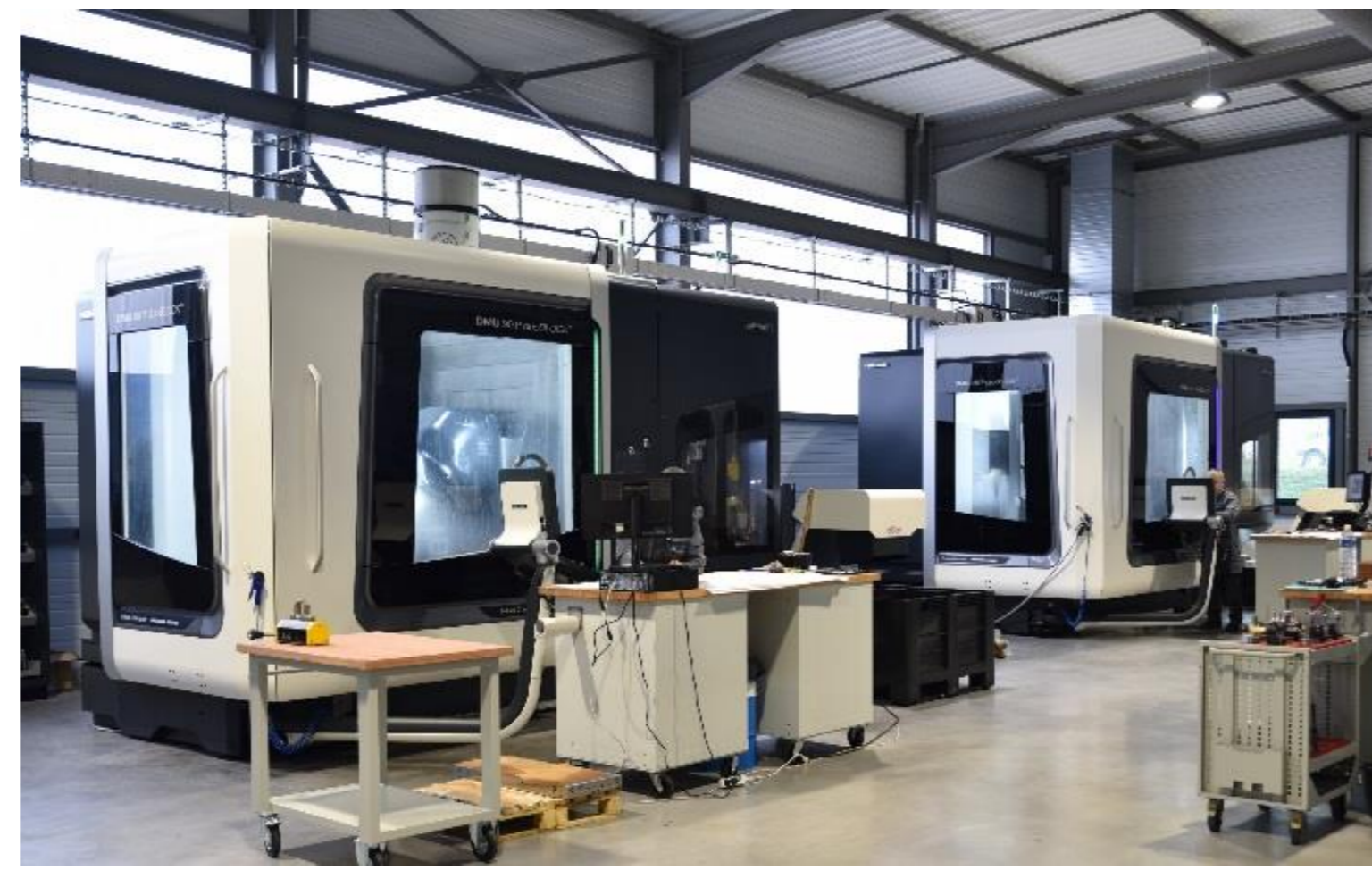

IT+3
INNOVATION



NOS MOYENS: PARC MACHINE



12 centres d'usinage 5 axes



4 centres de tournage 4 et 5 axes



2 Machines de mesure
Tridimensionnelle



1 banc de pré réglage
1 banc de frettage



3 Machines d'électroérosion



5 machines de rectification



IT+3
INNOVATION



EXEMPLES DE MONTAGES D'USINAGE

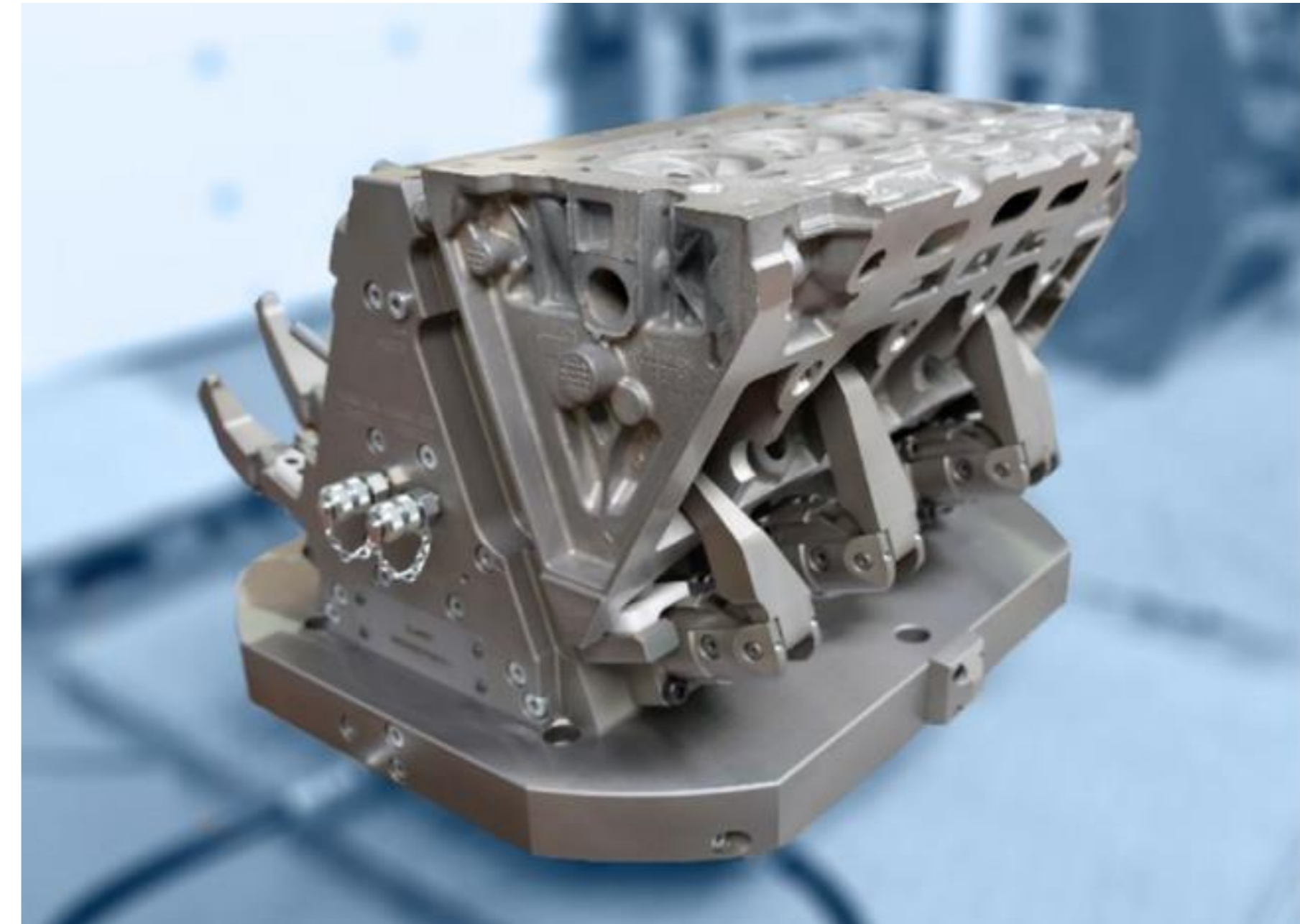

IT+3
INNOVATION



EXEMPLES DE MONTAGES D'USINAGE

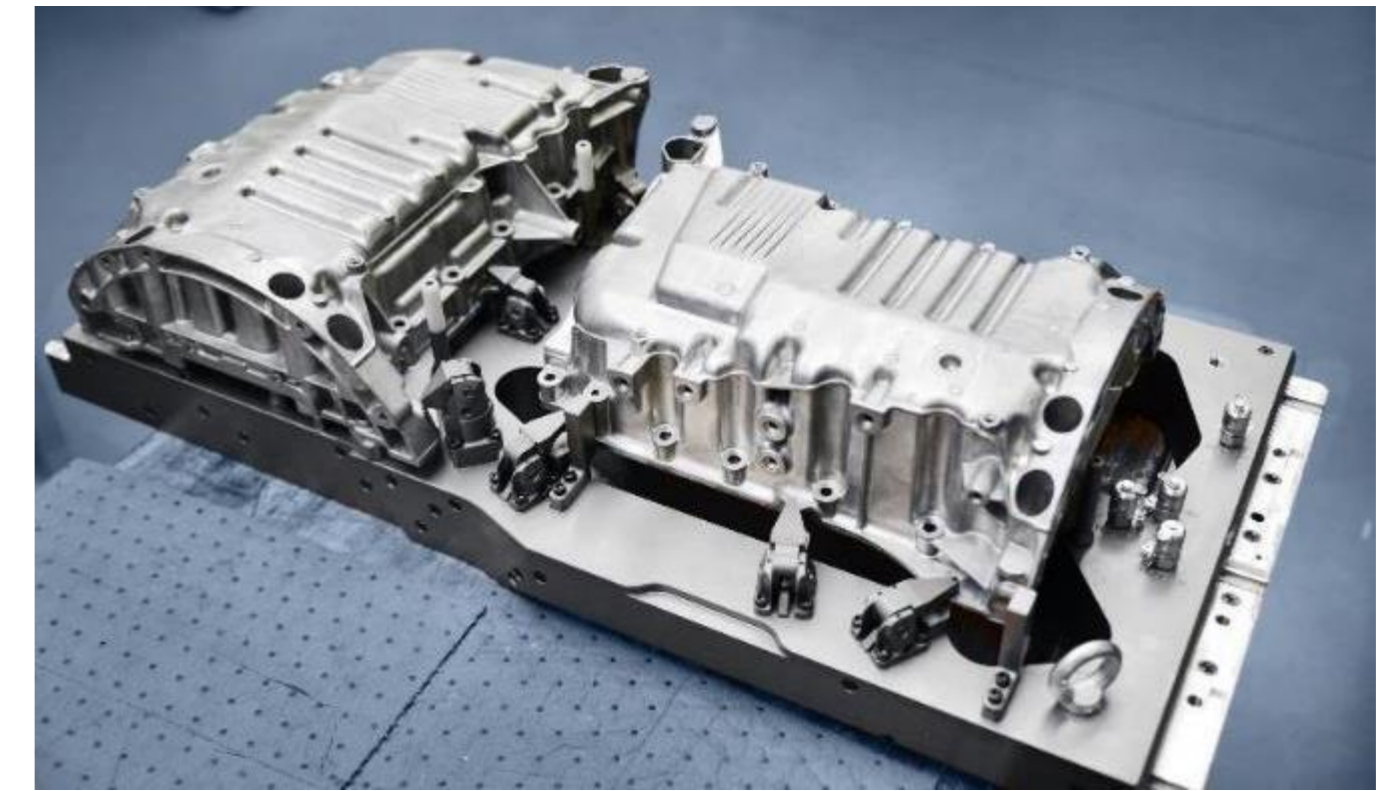
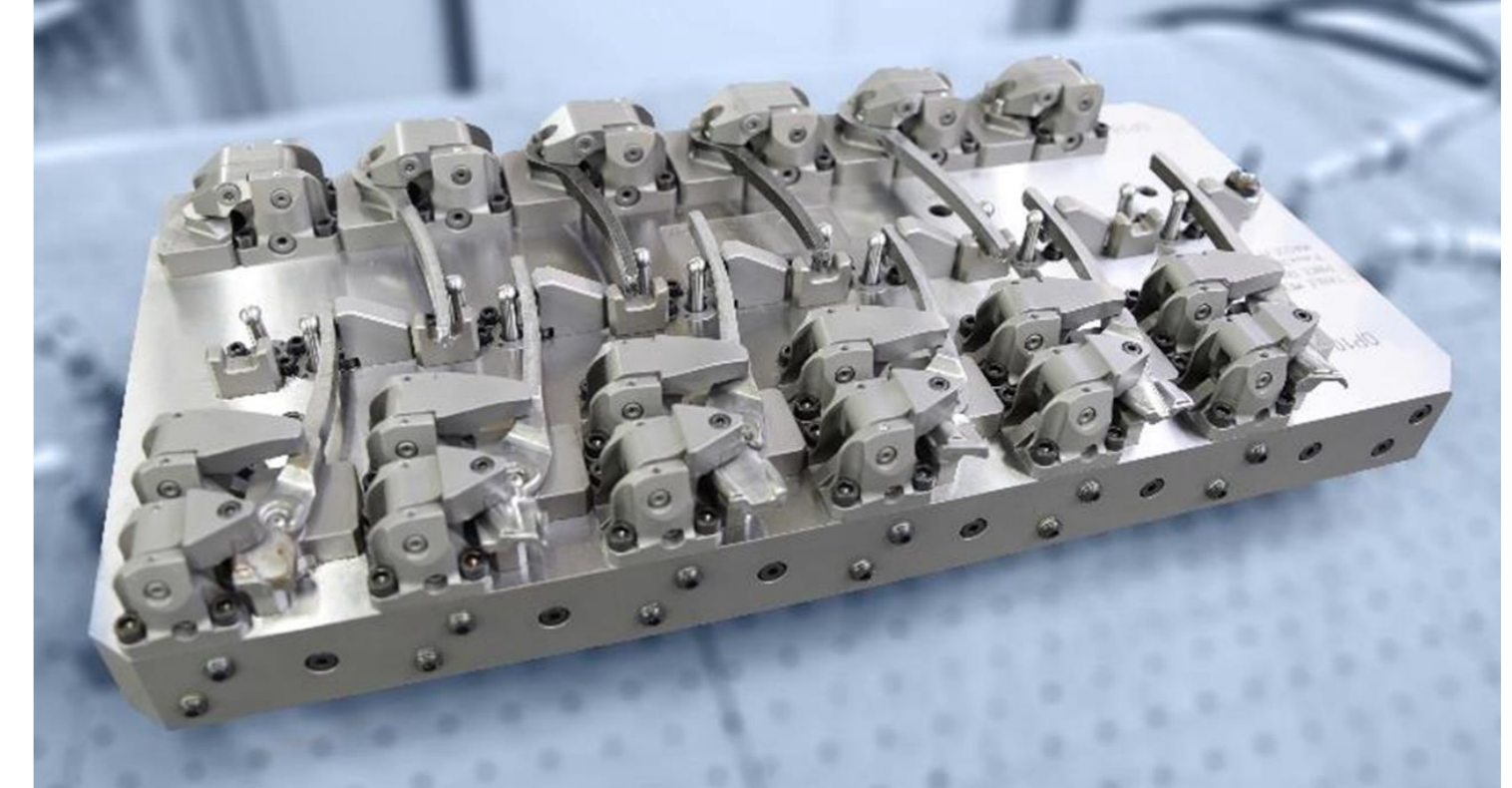
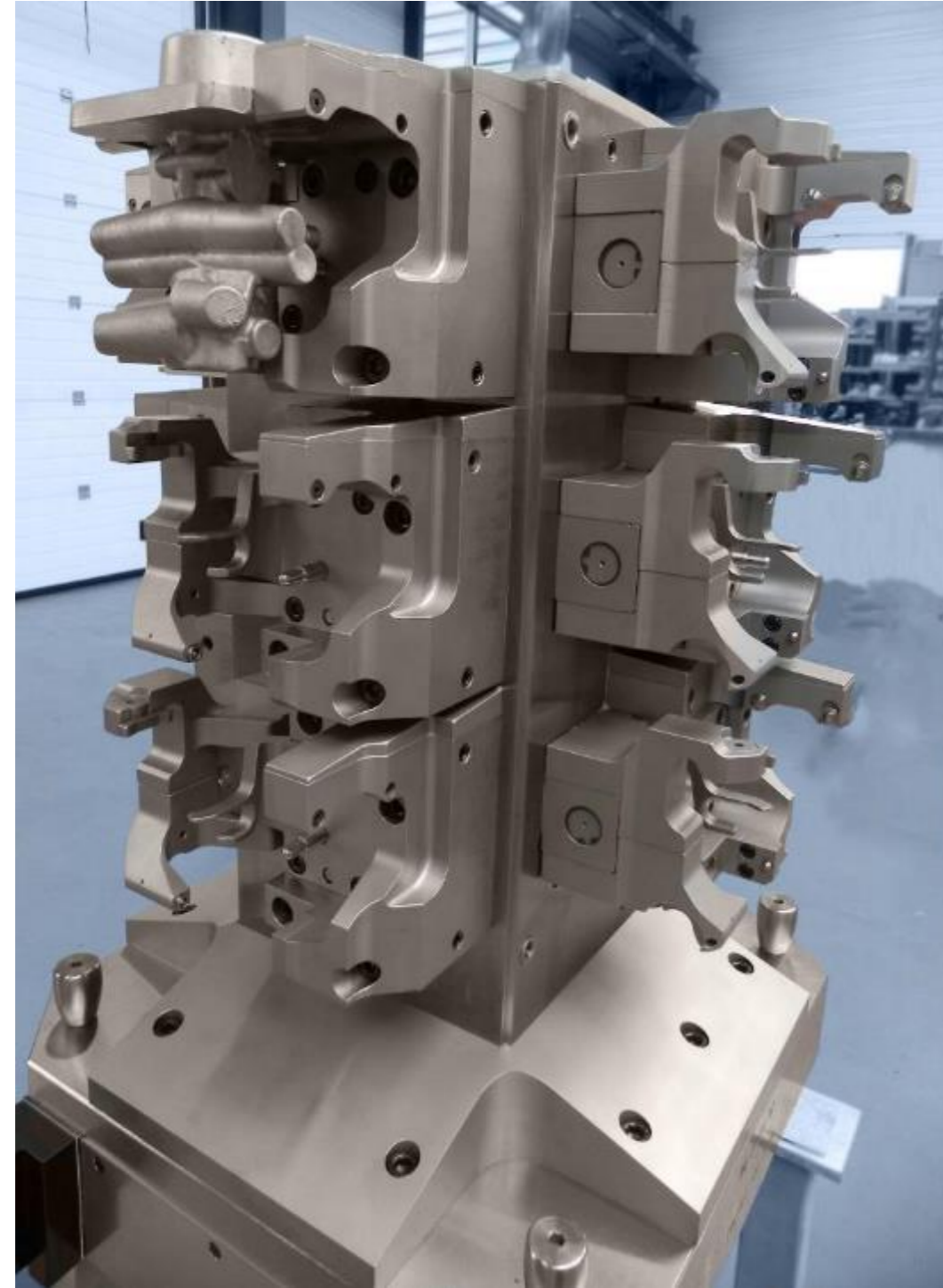

IT+3
INNOVATION



EXEMPLES DE MANDRINS SPECIAUX

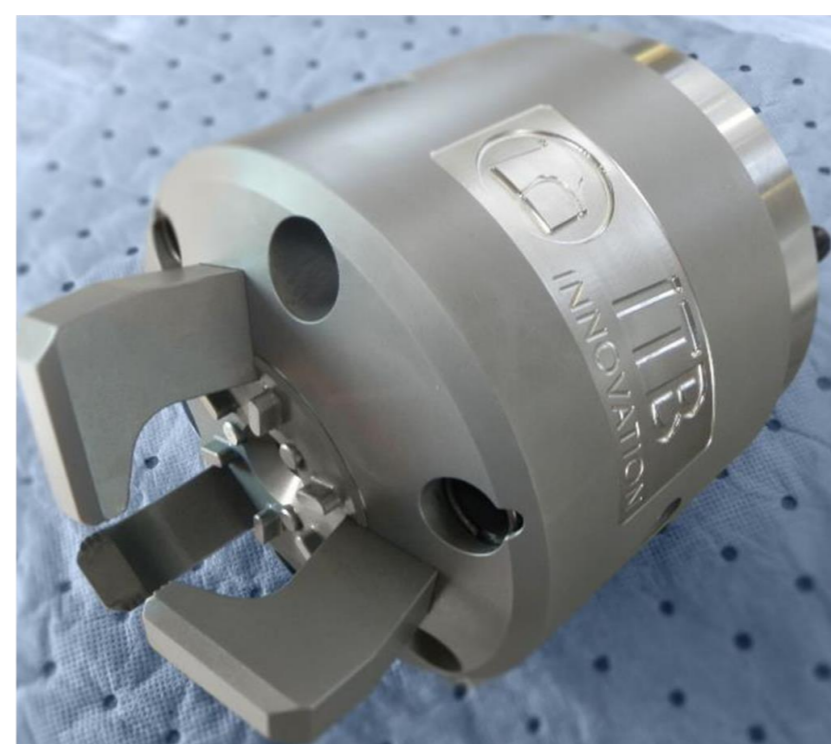
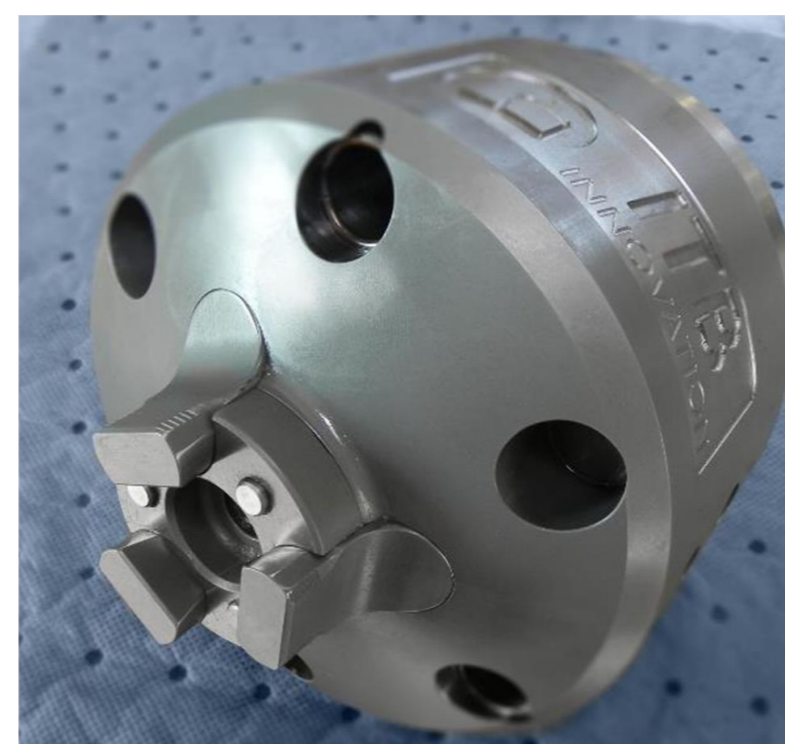

IT+3
INNOVATION



EXEMPLES DE MANDRINS SPECIAUX

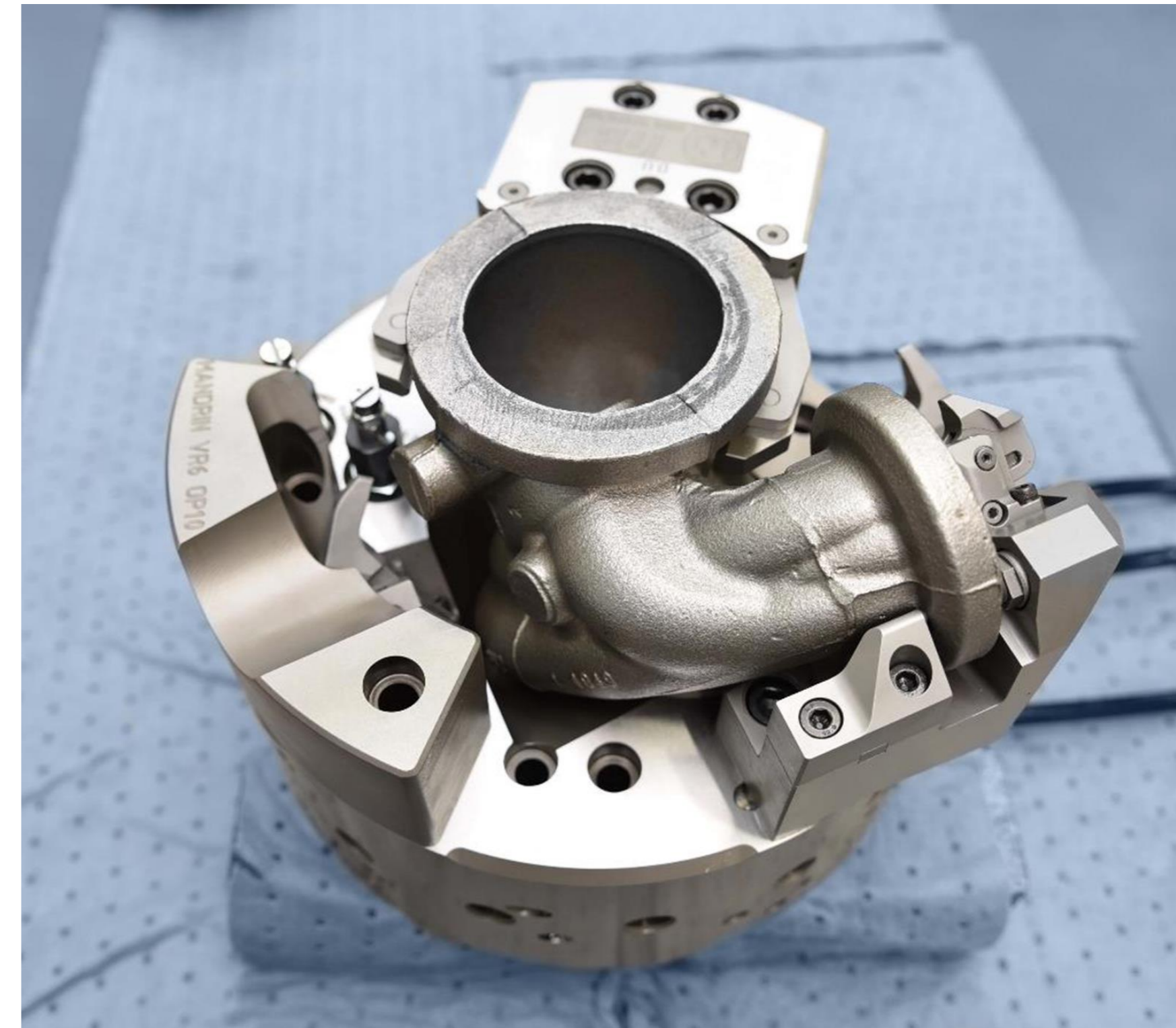
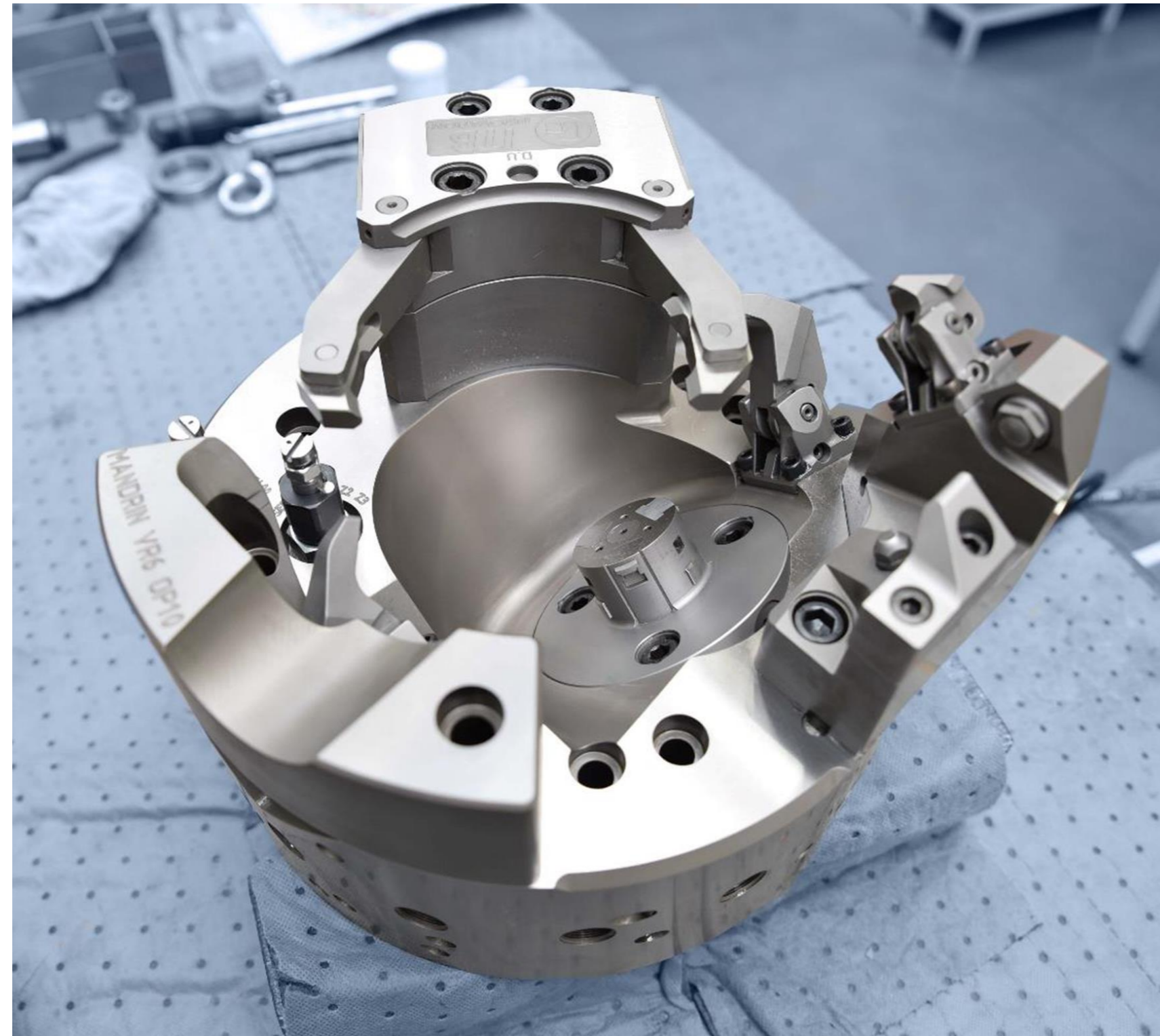

IT+3
INNOVATION



EXEMPLES DE MANDRINS SPECIAUX

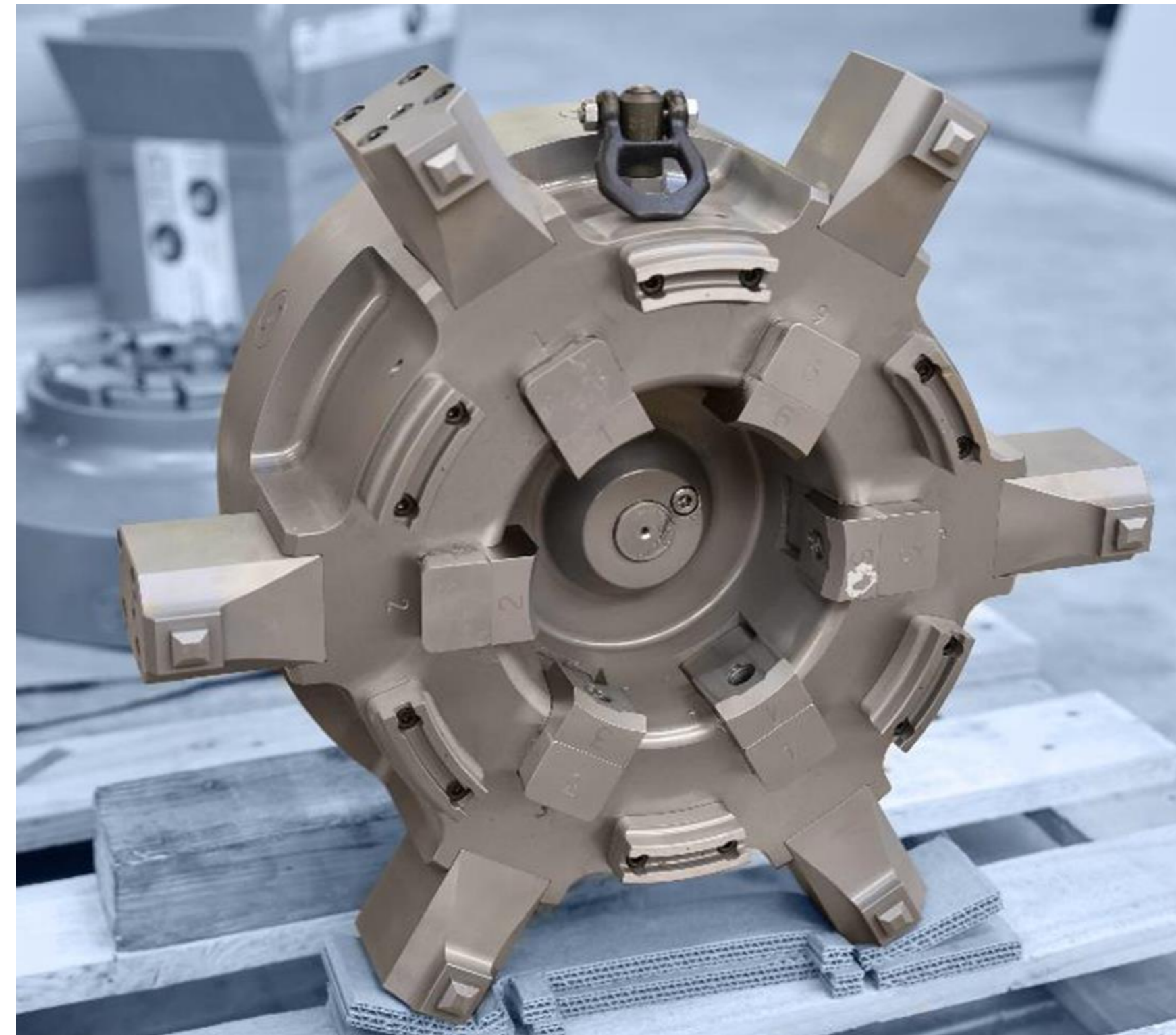

IT+3
INNOVATION



Contact



Z.I De la Craye
25 110 AUTECHAUX
FRANCE

Vos Interlocuteurs

Christophe Boiteux

PDG

 +33 6 80 85 60 71

 cboiteux@itb-innovation.com

 www.itb-innovation.com

Stéphane Dornier

Responsable Bureau d'études

 +33 3 81 56 15 94

 sdornier@itb-innovation.com

 www.itb-innovation.com

Jean-Paul Ezcurra

Ingénieur Commercial

 +33 6 70 31 31 33

 jpezcurra@itb-innovation.com

 www.itb-innovation.com



IT+3
INNOVATION



