



IPCs for any application:  
from automation  
to infrastructure.

Selecting an Industrial PC (IPC) from Beckhoff opens the door to a superior hardware solution that perfectly meets the requirements of any application. Whether for industrial or building automation, power generation or infrastructure, HMI or IoT applications, as the central platform in a complete Beckhoff control solution or just an IPC – all Beckhoff IPCs come with a built-in competitive edge. They are backed by a unique technological philosophy and superior in-house production processes.



Process Industries



Communication, IoT



Automation

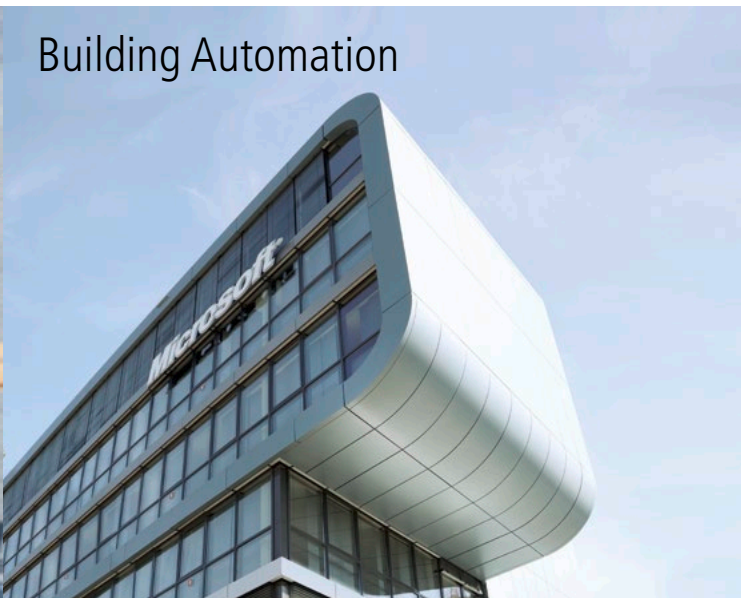

Building Automation



HMI, Visualisation



Infrastructure



Power Generation

All kinds  
of IPCs.  
But all of the  
Beckhoff kind.

As a pioneer in industrial automation, Beckhoff offers a highly scalable portfolio of IPCs for any kind of installation format and protection class requirement. They have one thing in common – the Beckhoff look and feel. Starting with our selection of materials our engineers ensure that superior technological standards are reflected in the attractive design, high-quality build and surface finish of every product. The end result is a consistent, state-of-the-art user experience.



## Control cabinet IPCs

These IPCs from Beckhoff are designed for installation in control cabinets and enclosures. An IPC and a Beckhoff Control Panel are an ideal combination and provide a versatile platform for machine and factory applications, especially with TwinCAT automation software.



## Embedded PCs

The compact, DIN rail-mountable PCs from the CX series can be combined with a wide range of I/O modules to implement space-saving industrial control systems in control cabinets. Embedded PCs from Beckhoff are completely scalable according to your budget, performance requirements and control task complexity.



## Panel PCs

Beckhoff Panel PCs are equipped with powerful processors ranging from ARM Cortex™ to Intel® Atom™ up to Intel® Core™ i7. For each application, we offer a matching Panel PC in a wide range of screen sizes based on your available space and performance requirements.



## Control Panels

Beckhoff Control Panels are designed for installation in cabinets or on mounting arms. They feature up to IP 65 protection class and can be operated at distances up to 100 meters away from the PC. Available in many screen sizes as well as 4:3, 5:4 and 16:9 aspect ratios, Beckhoff Control Panels offer the ideal industrial display for any application.

More than  
30 years  
of expertise:  
built into  
every IPC.

More than 30 years ago, Beckhoff developed the principle to use PC-based control technology for automated processes. The knowledge and expertise needed to design and build a great variety of Industrial PCs in-house has grown steadily ever since. Because of this and the close relationships between Beckhoff and global IT innovators such as Microsoft and Intel, users of Beckhoff IPCs will always enjoy a technological advantage.

Milestone: First all-in-one  
PC motherboard

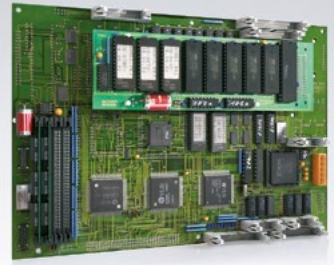

1990



First PC-based  
machine controller

1986

Milestone: First Control Panel operation separate from the IPC



1998

Milestone: First modular Embedded PC for DIN rail mounting



2002

Milestone: Industrial server for many-core control



2014

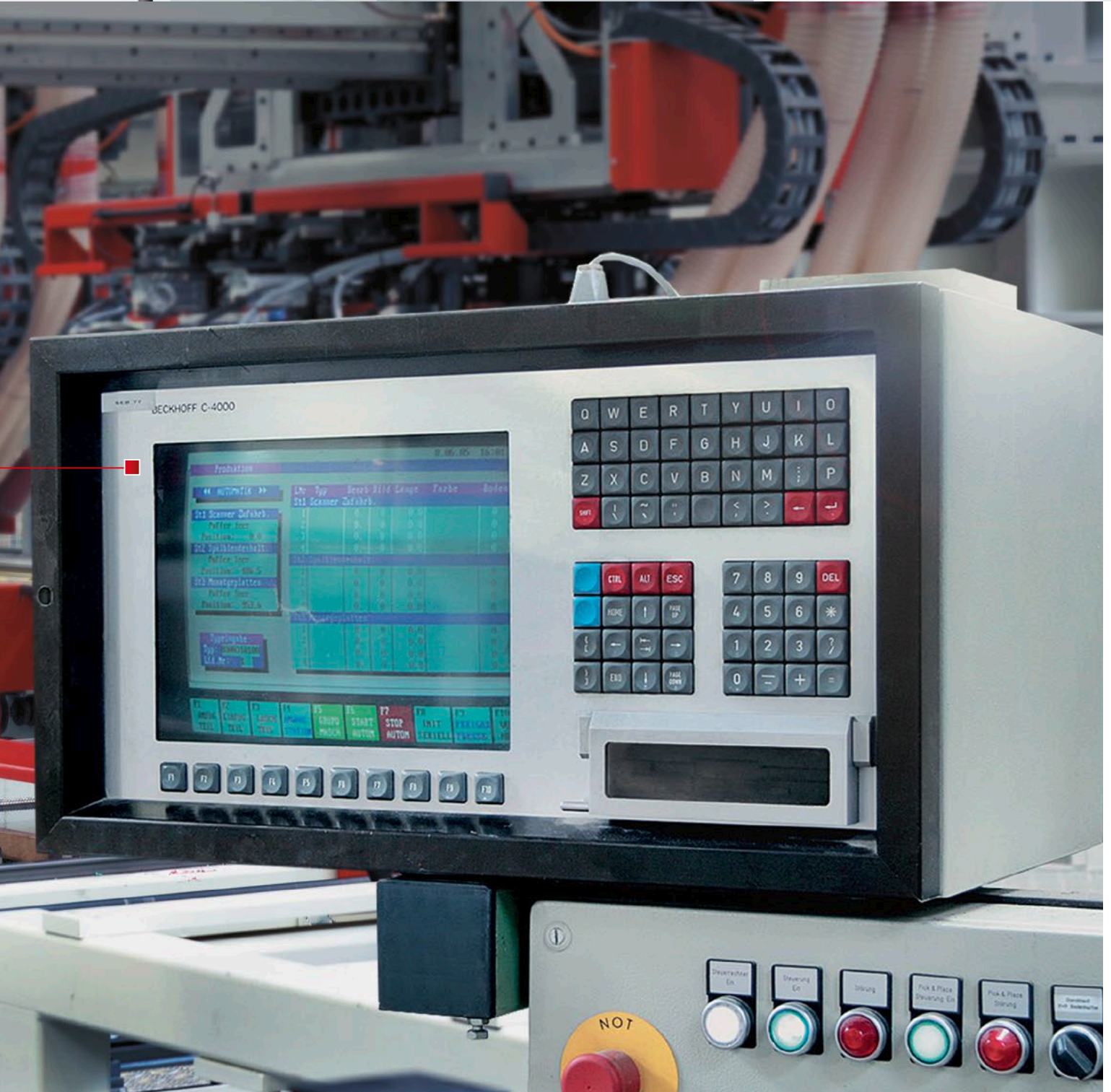

Our hardware,  
our software,  
premium design:

Only the combination  
makes an IPC  
a Beckhoff IPC.

- In-house development, design and production of motherboards, housings and transmission technology
- Highest mechanical and electrical stability
- Highly compact designs
- Hard real-time PC-based control
- Approved with TwinCAT software
  
- In-house BIOS programming and configuration for various CPUs and chipsets
- Appropriate selection of hardware drivers
- Perfect integration of the EtherCAT protocol
- Perfectly harmonised hardware and software system
- Consistent compatibility across product portfolio
  
- Premium look and feel
- Unmistakable Beckhoff design
- High-quality materials and appearance

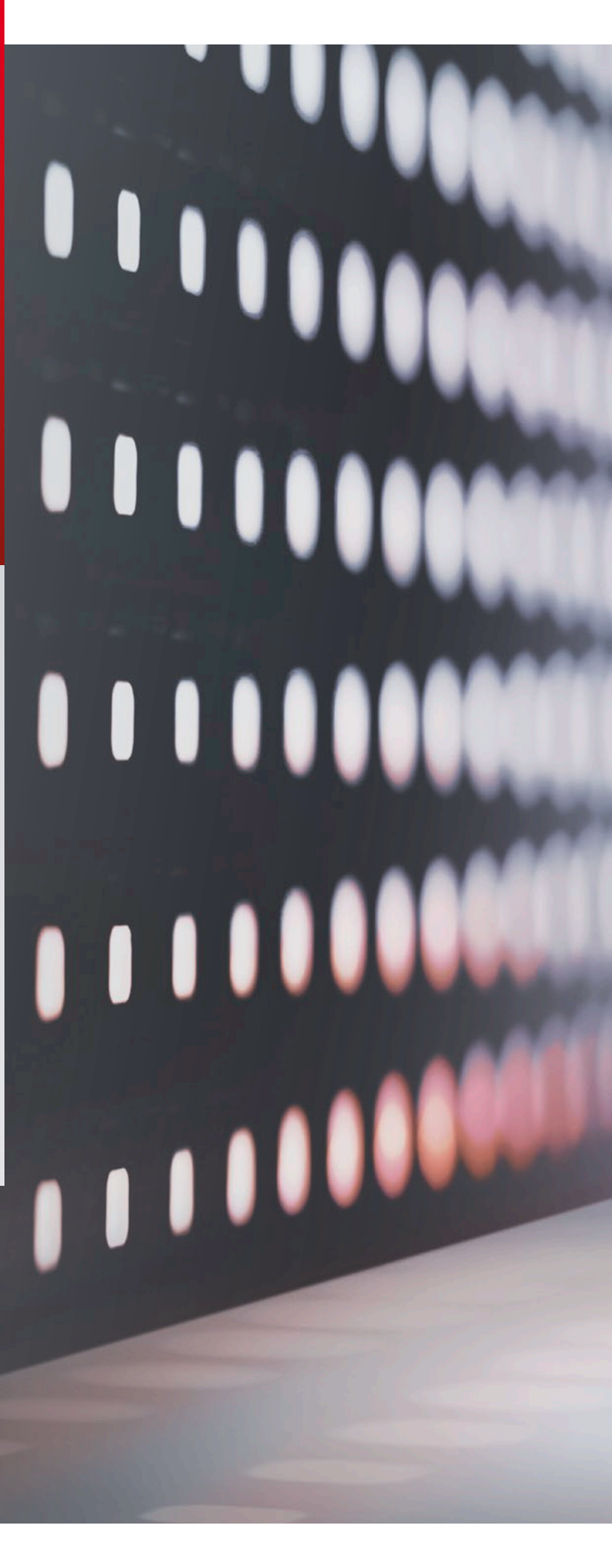



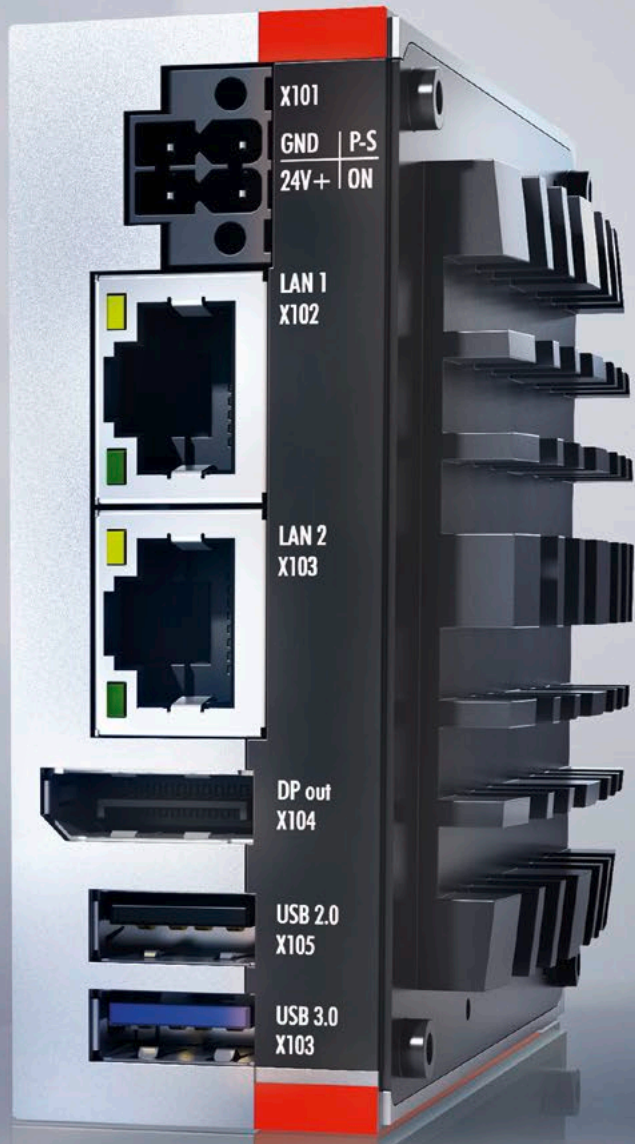

X101  
GND | P-S  
24V+ | ON

LAN 1  
X102

LAN 2  
X103

DP out  
X104

USB 2.0  
X105

USB 3.0  
X103

X103  
028 30

Hardware:  
in-house.  
Performance testing:  
in-house.  
Advantage:  
in-house.

How do you achieve best-in-class mechanical and electronic stability for highly available and powerful IPC technology? The keys are to develop, design and manufacture in-house. At Beckhoff, this seamless chain of integrated processes begins with the in-house production of motherboards. It ends with rigorous in-house testing to validate the performance of the hardware in interaction with TwinCAT control software. As a user, you can count on long-term product availability and a complete system that is optimally coordinated.

**Shock- and vibration-proof**

**International approvals**

**Exchangeable storage media**  
▪ scalable configuration

**Convenient component accessibility**  
▪ very maintenance-friendly

**100 % in-house motherboard development – Designed in Germany**  
▪ system from a single source

**100 % in-house motherboard production – Made in Germany**  
▪ end-to-end traceability

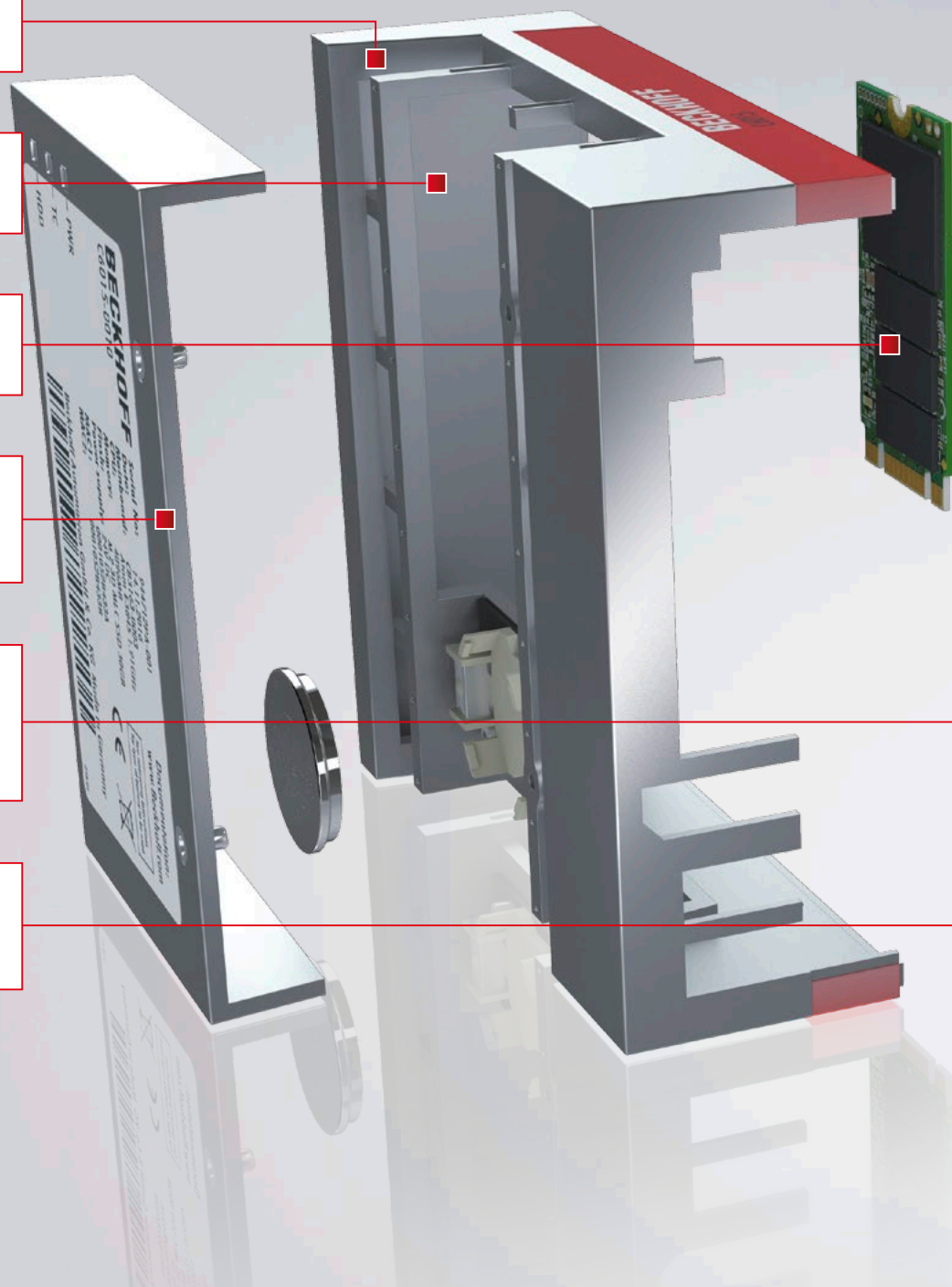

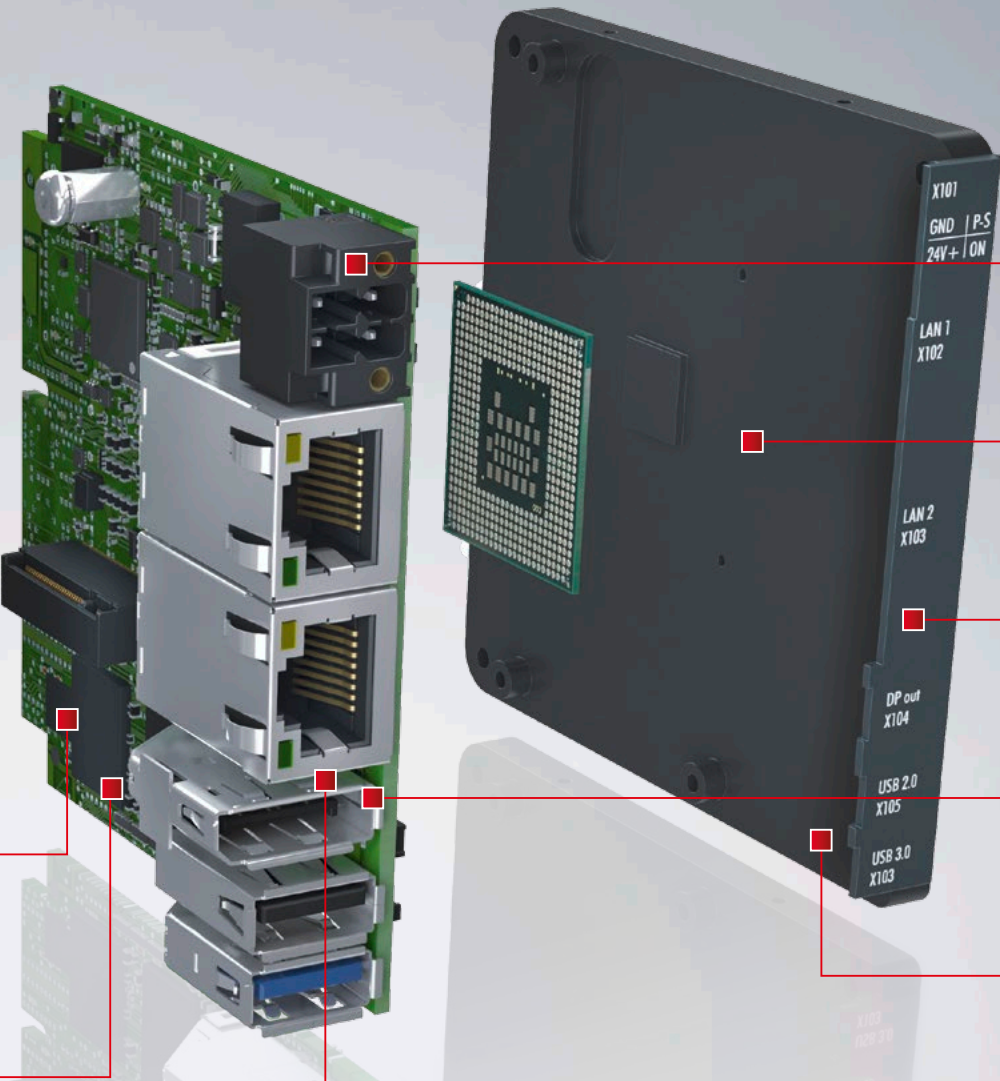

**Flexible installation options**

**Flexible form factors**  
▪ optimised for any application

**Industrial temperature ranges**

**Passive cooling concepts**  
▪ maintenance-free operation

**Long-term available components**  
▪ highest investment security

**EMC-optimised design**

**Robust ports and connections**

# Beckhoff BIOS and diagnostics: the best software for the Beckhoff hardware.

High performance hardware needs capable software to match. With the company's own BIOS development, Beckhoff can offer fully customised software packages. The same applies to our Windows operating system image development and our IPC diagnostics for standardised access to all IPC information. Our in-house software development also ensures the system's real-time capability to perform TwinCAT real-time tests and adapt the IPC software even more precisely to the hardware.

## Integrated diagnostics

- minimised downtime

## Optional RAID data storage

- highest data availability

## Integrated security

- protection against unauthorised access

## Operating systems with long-term availability

- long-term machine concepts

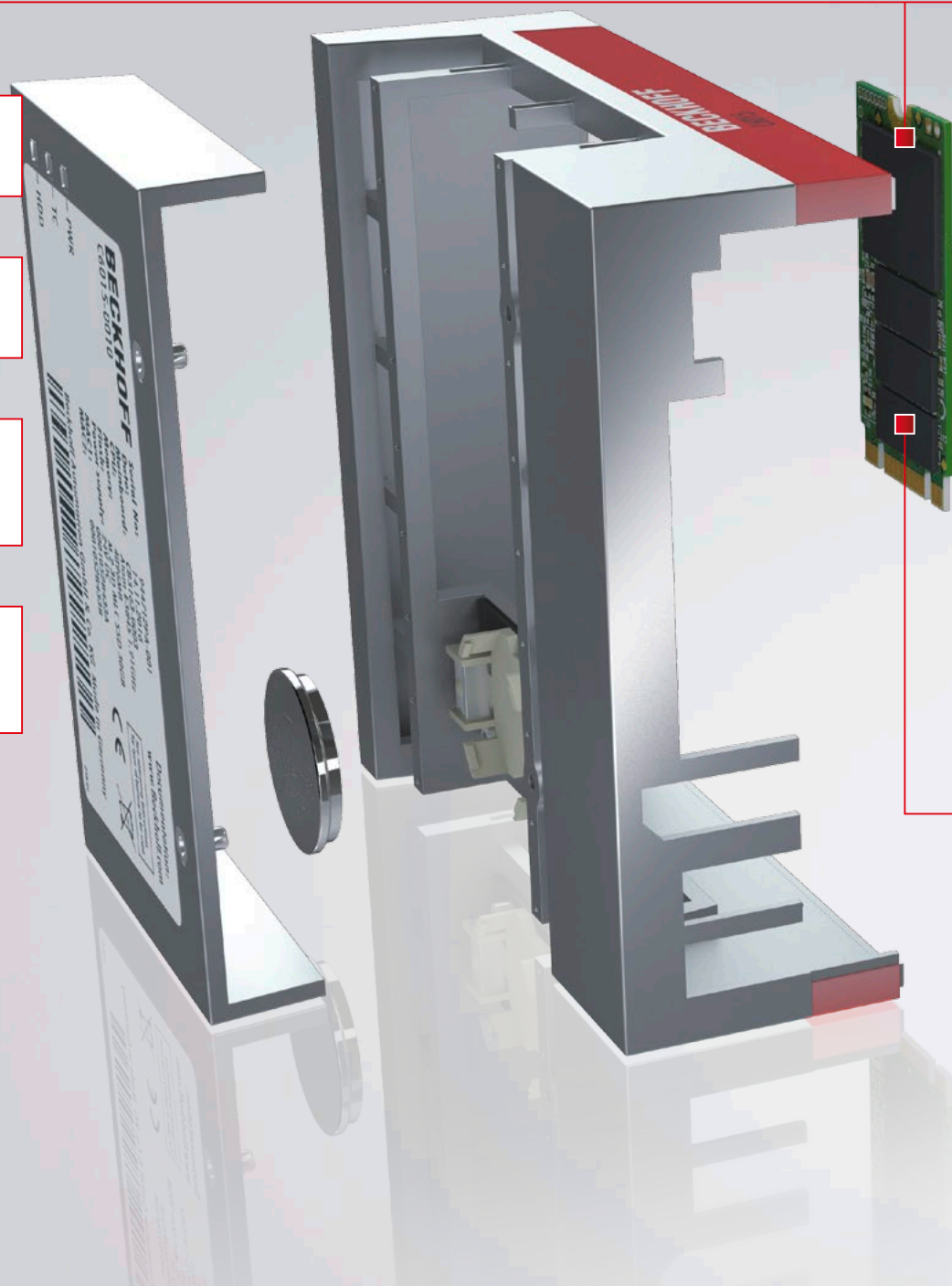

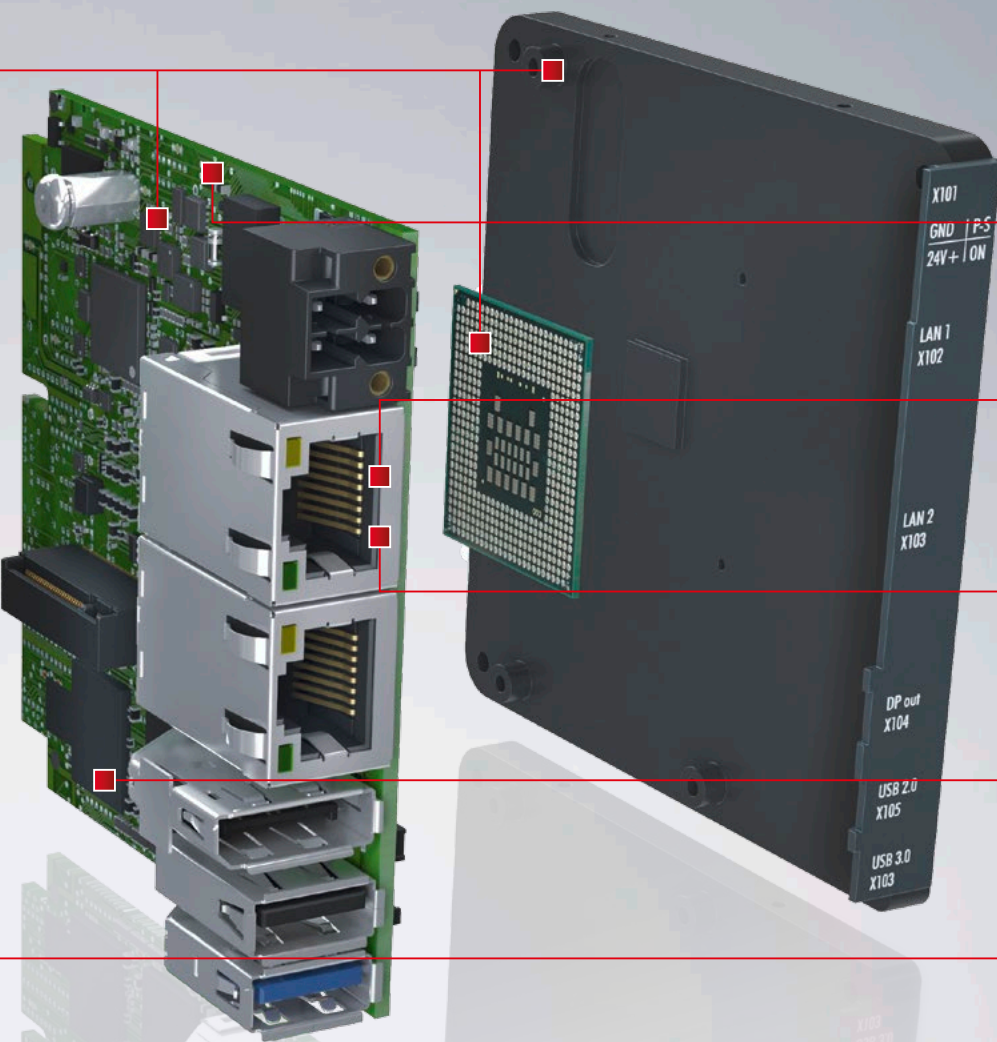

**Optimised TwinCAT control software platform**

**Optional IoT communication**  
▪ for all applications

**EtherCAT-compatible interfaces**  
▪ real-time capable up to cycle times of 12.5  $\mu$ s

**Beckhoff BIOS**  
▪ optimised system stability

**In-house image creation**  
▪ customer-specific adaptations

Superior  
technology at  
first sight.  
Premium  
look and feel.

The unmistakable design and high-quality finish of Beckhoff IPCs are fixed parameters of product development from the start. The housings of our Control Panels are prime examples, which are milled from a solid block of aluminium. We manufacture the housings this way because we want our premium design philosophy to be apparent and tangible for the end customer while at the same time enhancing the value of machines and systems. In many cases, Panel PCs or Control Panels serve as front-ends with high recognition value.



reddot design award



#### CX2020

Revolution on DIN rail: The powerful CX2020 combines high computing performance in a compact design with direct connection to the I/O system.



Control Panels in special stainless steel housings are used in the most demanding environments, such as the food, beverage and pharmaceutical industries.



reddot design award



### Multi-touch panels on mounting arms

Arm-mounted sophistication: The fully IP 65-compliant Control Panels in robust anodized aluminium housings with tempered-glass fronts can be used for many applications.



### C6015

Flexibility redefined: With exceptional space and cost savings, the ultra-compact C6015 IPC is the ideal solution for a multitude of control applications.



### CX8190

Functionality meets high-end design: The CX81xx Embedded PC series in Bus Coupler format delivers impressive computing performance in an ultra-compact controller using TwinCAT 3 software.



Highly scalable  
and customisable:

Only the combination  
ensures a perfect fit  
for your application.

- Flexible form factors
- Scalable CPU architectures: ARM, x86
- Storage media flexibility: HDD, SSD, CFast,  $\mu$ SD
- Wide range of interfaces and screen sizes
- For all protection classes and installation requirements
  
- Customised models in terms of mechanics, electrical and electronic components, software and design
- Integration of external hardware
- Integration of industry-specific functionalities
- Tailored to specific applications and corporate design guidelines







As broad as  
the application  
spectrum itself:  
the IPC portfolio

## Performance



ARM Cortex™-A9,  
800 MHz



ARM Cortex™-A8,  
1 GHz



Intel® Atom™ E3815,  
1.46 GHz

Select the Beckhoff IPC that perfectly matches the job. Beckhoff offers a highly scalable portfolio of IPCs ranging from single-core to multi-core and many-core with all types of interfaces, display sizes, form factors with different or identical CPUs, and various protection classes. Another key benefit is guaranteed long-term availability throughout the product portfolio – a total of five years for Industrial PCs and 10 years for Embedded PCs. End customers enjoy peace of mind knowing that their products will be supported in the long term: through hardware updates with easy CPU integration in the same form factor, reduced cost of software images and training, as well as fast customer service response times.

## Variety



Multi-touch Panel PC



Control cabinet  
Industrial PC



19-inch slide-in Industrial PC



“Economy” control  
cabinet Industrial PC

## Display connectivity solutions

DVI/USB: up to 50 m



IP 20



IP 65

## Display sizes



7-inch



12-inch



15-inch



15.6-inch



Intel® Atom™ E3845,  
1.91 GHz, 4 cores



Intel® Core™ i7 2715QE  
2.1 GHz, 4 cores



Intel® Xeon® D-1559  
1.5 GHz, 12 cores



7-inch "Economy"  
built-in Panel PC



Fanless built-in  
Industrial PC



Multi-touch  
Control Panel with  
push-button extension



Control cabinet Industrial PC



Embedded PC



Control cabinet  
industrial server

CP-Link 4: up to 100 m

Panel PC



IP 20



IP 65



IP 20



IP 65

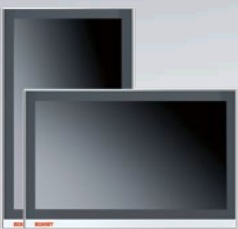

18.5-inch



19-inch



21.5-inch

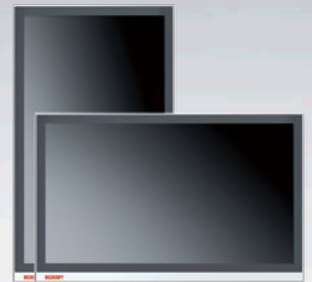

24-inch

Great variety  
from the start:  
standard IPCs  
with variable  
configuration.

Almost no applications are exactly alike, and neither are most of the standard IPCs from Beckhoff. Their flexibility in configuration allows users to choose exactly the devices that are best-suited to their specific applications. With processors ranging from Intel® Celeron® to Core™ i7, different RAM and storage options, various operating systems and TwinCAT generations – the menu of options is vast, resulting in an almost unlimited variety of standard IPC models.



# Processors



Intel® Celeron®



Intel® Pentium®



Intel® Core™ i3



Intel® Core™ i5

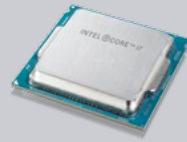

Intel® Core™ i7

# Main memory



4 GB DDR4 RAM



8 GB DDR4 RAM



16 GB DDR4 RAM



32 GB DDR4 RAM

# Mass storage



2 1/2-inch HDD



2 1/2-inch SSD



CFast

# PCIe modules



CP-Link 4



Ethernet



USB 3.0



COM (RS232,  
RS485, RS422)



NOVRAM



PROFIBUS



PROFINET



DVI

# Software



Windows 7



Windows 10

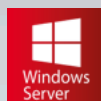

Windows  
Server



RAID



32/64 Bit



Diagnostics



UPS



TwinCAT 2



TwinCAT 3

As desired:  
customer-specific  
features  
and designs.

Your  
labels.



Your  
configuration.



Your  
features.



Your  
Corporate  
Design.



Besides the high scalability of the Beckhoff IPC portfolio and the ability to configure standard IPCs individually, Beckhoff IPCs can be designed and built for customer-specific requirements. The spectrum of options is exceptionally broad and ranges from company logos or special labels and individualised functions to IPCs built in total accordance with the customer's corporate design.

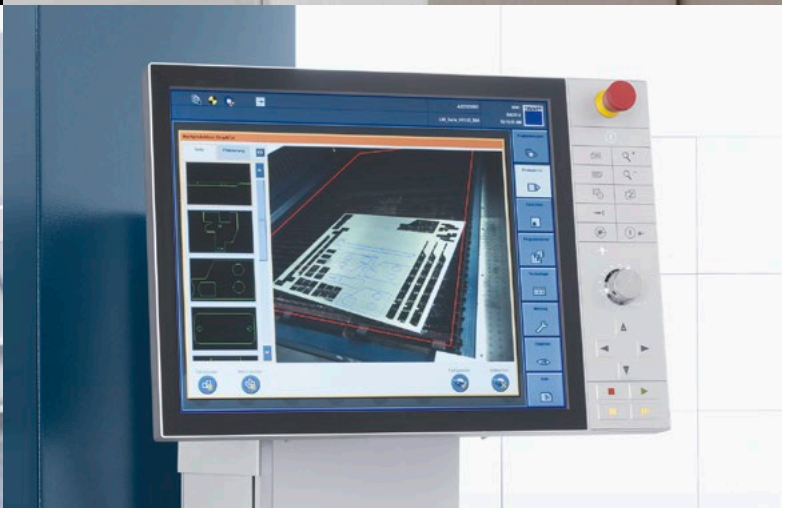

Globally available  
for decades:

Only the combination  
ensures optimum  
investment protection.

- Long-term availability of standard form factors
- Long-term stocking of processors and chips
- Complete support for the product lifecycle
- Long-term availability of all IPC series in the portfolio
  
- Long-term strategic stocking of components to ensure supply availability
  
- Availability in more than 70 countries
- Globally available service







State-of-the-art  
manufacturing  
standards and  
superior stock  
management.

Each Beckhoff IPC comes with maximum delivery reliability and investment protection. Besides featuring form factors and model series with long-term availability, Beckhoff virtually eliminates supply bottlenecks through superior inventory and stock management. By keeping up to six months' worth of raw materials and components in stock, Beckhoff can deliver even when global market conditions become challenging.

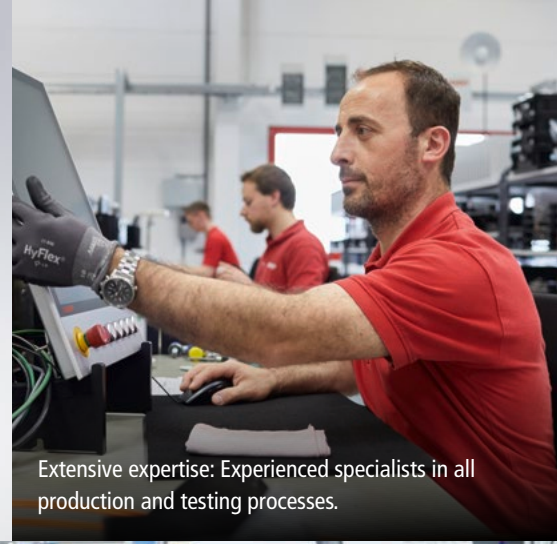

Extensive expertise: Experienced specialists in all production and testing processes.



High level of vertical integration: With fully automated electronics manufacturing systems, Beckhoff ensures highest quality over the entire lifecycle of each product.

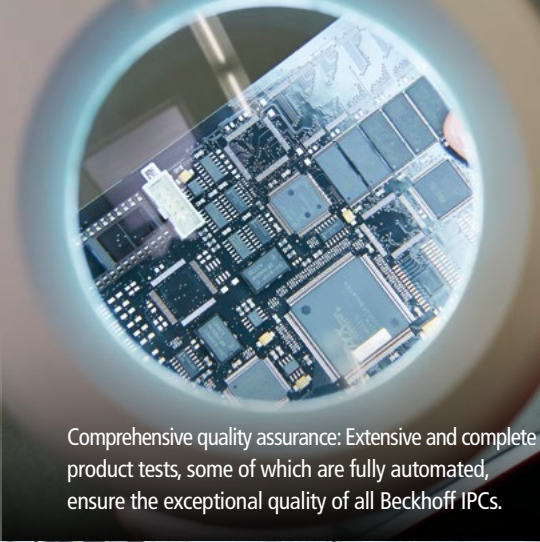

Comprehensive quality assurance: Extensive and complete product tests, some of which are fully automated, ensure the exceptional quality of all Beckhoff IPCs.

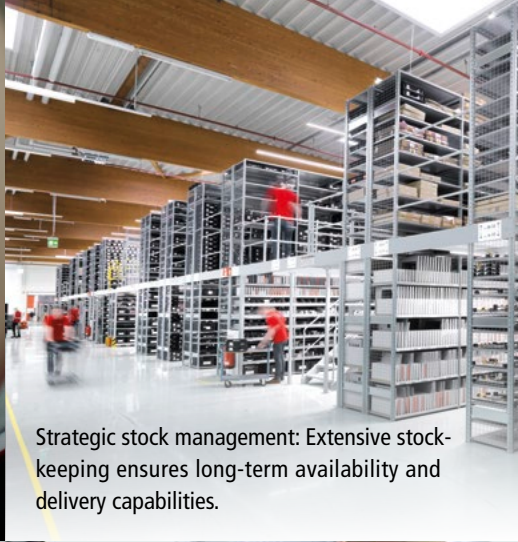

Strategic stock management: Extensive stock-keeping ensures long-term availability and delivery capabilities.



Flexible assembly concept: Strategic capacity and production planning for reliable delivery performance of lot sizes as small as one.







Owner-led management and a strong team spirit provide the foundation for continuous innovation.

### Beckhoff at a glance

- Headquarters Verl, Germany
- Sales 2016: 679 Mio. € (+9,5 %)
- Staff worldwide: over 3,350
- Sales/Technical Offices Germany: 19
- Subsidiaries/Branch Offices worldwide: 35
- Distributors worldwide: in more than 75 countries
  
- (as of 04/2017)

► [www.beckhoff.com](http://www.beckhoff.com)

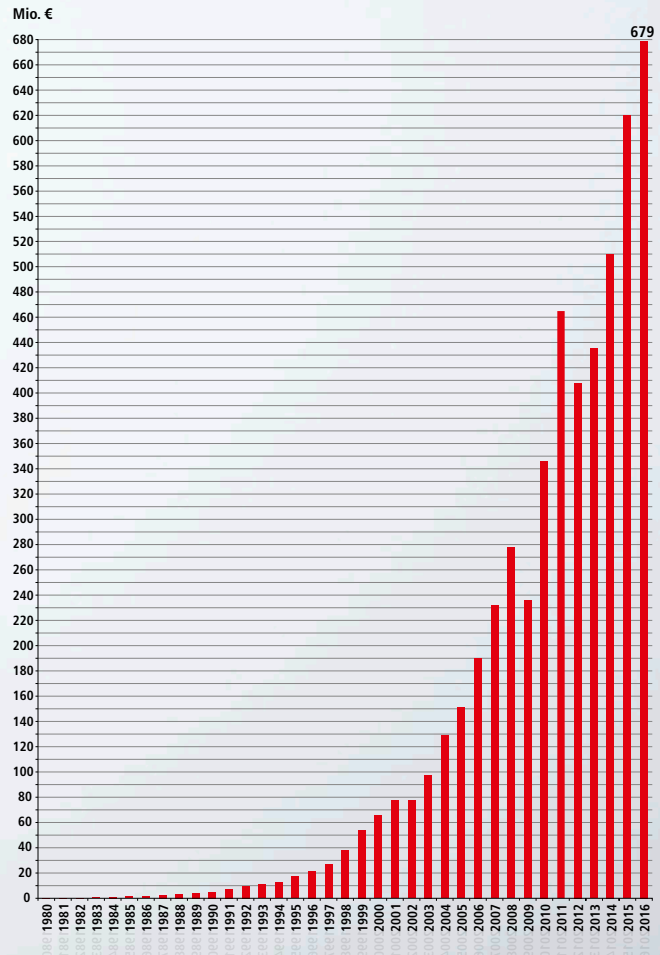

Sales development

- Headquarters
- Subsidiary
- Headquarters distributor
- Subsidiary distributor

Take the lead with  
IPC technology from Beckhoff:  
► [www.beckhoff.com/ipc](http://www.beckhoff.com/ipc)

**Beckhoff Automation GmbH & Co. KG**

Huelshorstweg 20

33415 Verl

Germany

Phone: +49 5246 963-0

[info@beckhoff.com](mailto:info@beckhoff.com)

[www.beckhoff.com](http://www.beckhoff.com)

Beckhoff®, TwinCAT®, EtherCAT®, EtherCAT P®, Safety over EtherCAT®, TwinSAFE®, XFC® and XTS® are registered trademarks of and licensed by Beckhoff Automation GmbH. Other designations used in this publication may be trademarks whose use by third parties for their own purposes could violate the rights of the owners.

© Beckhoff Automation GmbH & Co. KG 11/2017

The information provided in this brochure contains merely general descriptions or characteristics of performance which in case of actual application do not always apply as described or which may change as a result of further development of the products. An obligation to provide the respective characteristics shall only exist if expressly agreed in the terms of contract.

Picture credits: Avantis Energy Group | BMW AG | foto-werk.ch | Gefasoft GmbH | GF Machining Solutions Management SA  
Husky Injection Molding Systems Ltd | Kevin Burke (Getty Images), KÖRA-PACKMAT Maschinenbau GmbH | MBP S.r.l.  
TRUMPF GmbH + Co. KG | Microsoft Corporation | MMC Packaging Equipment Ltd. | MULTIVAC Sepp Haggenmüller SE & Co. KG  
nobilia-Werke J. Stickling GmbH & Co. KG | Peitzmeier Maschinenbau GmbH | Scheugenpflug AG  
Uhlmann Pac-Systeme GmbH & Co. KG | yoh4nn (Getty Images)