

Centrage • Pointage

La précision, la géométrie, la protection des trous de centres sont les garants de la qualité des opérations d'usinages ultérieures. Chacun des 10 profils proposés a été conçu pour leur amélioration ainsi que pour optimiser les performances de vos machines. Parmi nos 124 gammes, il existe pour tous les cas de centrage / pointage une solution adaptée. Elles correspondent à toutes les normes connues en métrique ou en pouces et à toutes les qualités aujourd'hui possibles : **HSS / HSS-CO / HSS 8% CO / CARBURE** pour les matières, **TiN / Red'X / Hard'X** pour les revêtements. Soit un choix de 1 300 dimensions disponibles! **Qui offre plus ?**

Centering • Spotting

The accuracy, the geometry and protection of center holes will secure the quality of the ultimate machining operations. Each of the 10 available profiles has been designed to maximize their application. This will also optimise your machine performance. Among our 124 ranges, for all kind of centering / spotting operations there is an adapted solution. These correspond to all metric or inch standards in all currently available base materials : **HSS / HSS 5% CO / HSS 8% CO / CARBIDE** as base materials. **TiN / Red'X / Hard'X** for the coating. Resulting in more than 1 300 sizes! **Who offers more ?**

Centrado • Punteado

La precisión, la geometría, la protección de los agujeros de centrado garantizan la calidad de las operaciones de mecanizado posteriores. Cada una de las 10 propuestas ofrecidas han sido diseñadas para una mejora, así como para optimizar el rendimiento de su máquina. Entre nuestras 124 gamas, existe una solución adaptada a todos los casos de centrado / punteado. Estas corresponden a todas las normas conocidas en métrico o en pulgadas, en todas las calidades actualmente posibles : **HSS / HSS-CO / HSS 8% CO / METAL DURO** para los materiales, **TiN / Red'X / Hard'X** para los recubrimientos. ; Esto significa más de 1 300 medidas disponibles! ¿ **Quién ofrece más ?**

Centratura • Centratura NC

La precisione, la geometria, la protezione dei fori da centro sono essenziali per garantire la qualità delle lavorazioni successive. Ognuno dei 10 profili proposti è stato concepito per il loro miglioramento così da poter ottimizzare le prestazioni delle vostre macchine. All'interno delle nostre 124 varietà, esiste per ogni necessità di centratura la soluzione più idonea. Queste corrispondono a tutte le norme conosciute espresse tanto in mm quanto in pollici e con tutte le qualità possibili ad oggi : **HSS / HSSE / HSS-Co 8% / METALLO DURO** per quanto riguarda i materiali, **TiN / Red'X / Hard'X** per quanto riguarda i rivestimenti. Quindi una scelta fra ben 1 300 misure disponibili! **Chi offre di più ?**

New 2024

Forets à pointer NC NC spotting drill

Brocas de puntear CNC
Punte a centrare NC

60° **DUO-mag**
8116 / 8116H

> p. 34

142°

> p. 39

magafor

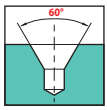

Centrage / Centering / Centrado / Centratura

**A**

➤ p. 18 ~ 21

➤ p. 22 - 23

➤ p. 23

➤ p. 18 ~ 21

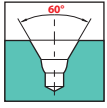
**W**

➤ p. 24 - 25

➤ p. 25

➤ p. 24

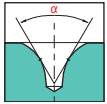
**R**

➤ p. 26 - 27

➤ p. 27

➤ p. 27

➤ p. 26 - 27

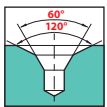
**B**

➤ p. 28 - 29

➤ p. 29

➤ p. 29

➤ p. 28 - 29

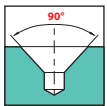
**90°**

➤ p. 28 ~ 30

➤ p. 23

➤ p. 30

82°

➤ p. 23

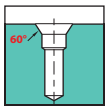
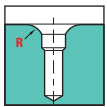
**D**Forets étagés à centrer
Combined center and step drills**DR***Brocas escalonadas de centrado*
Punte a centrare a gradino**DS**

➤ p. 32

Pointage / Spotting / Punteado / Centratura NC

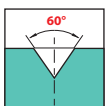
**60°**

➤ p. 34 ~ 40

➤ p. 34 ~ 40

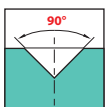
**90°**

➤ p. 34 ~ 43

➤ p. 35-40-43

➤ p. 35-40-43

➤ p. 34 ~ 43

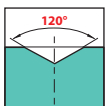
**100°**

➤ p. 95

➤ p. 95

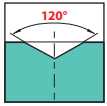
**120°**

➤ p. 36 ~ 43

➤ p. 36 ~ 43

➤ p. 36 ~ 43

➤ p. 36 ~ 43

142°

➤ p. 39

➤ p. 39

➤ p. 39

➤ p. 39

Special

➤ p. 31

Consultez-nous pour tous vos cas de centrage: nous mettrons notre expertise à votre service, pour vous offrir la meilleure solution.

Please inquire about any centering applications: we will offer you our expert opinion to offer the best solution.

Por favor consulten cualquier caso de centrado: Les ofreceremos nuestra experiencia para encontrar la mejor solución.

Consultateci per ogni vostra necessità di centratura: metteremo la nostra esperienza al vostro servizio per offrirvi la miglior soluzione.

Centrage • Pointage / Centering • Spotting

Centratura • Centratura NC / Centrato • Punteado

Comment choisir son foret ? How to choose your drill ?

Cómo elegir un broca de centrar ? / Come scegliere la punta a centrare ?

Centrage / Centering / Centrado / Centratura

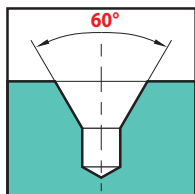

Forme A

Le foret à centrer 60° norme ISO est le type le plus universel.
The ISO standard 60° center drill is the most universal type.
La broca de centrar norma ISO 60° es el tipo más universal.
La punta a centrare a 60° a norma ISO rappresenta la tipologia universale.

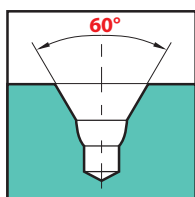

Forme B

Le chanfrein de protection garantit le centre contre tout risque de choc ou déformations.
L' évasement à 120° facilite la prise entre pointes sur machine automatique.
The protective chamfer guarantees the center from any risk of blows and deformation.
The 120° splay makes it easier to seize parts between points on machine with automatic feed.
El chaflán de protección garantizan el centrado obtenido contratodo riesgo de choque y deformación.
La 120° de protección facilita la unión entre puntos de las piezas sobre máquinas de alimentación automáticas.
El smusso di protezione garantisce il centro ottenuto contro ogni rischio di urti e di deformazioni.
La svasatura 120° facilita la presa dei pezzi fra le punte su macchine con caricamento automatico.

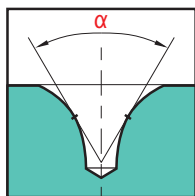

Forme R

Le rayon supprime l'amorce de rupture, assure une portée précise de la contrepointe et fait office de chanfrein de protection.
The radius eliminates the risk of breakage, provides an exact bearing, saves as a protective chamfer.
El radio suprime el riesgo de rotura, asegura un posicionamiento preciso del contra-punto e hace función de chaflán de protección.
Il profilo raggiato elimina i rischi di rottura, assicura una spinta costante della contro-punta, funge da smusso di protezione.

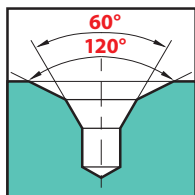

Forme W

Le bourrelet renforce la pointe, augmente le dégagement des copeaux, favorise la lubrification de la pointe.
The bulge reinforces the point, increases the chips removal, makes the lubrication of the drill easier.
La punta reforzada, aumento de evacuación de viruta, e Mejor lubricación de la broca.
Il bordino rinforza la punta, migliora l'evacuazione dei trucioli, y favorisce la lubrificazione della punta.

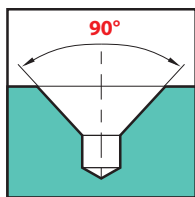

Centre angle 90°.
90° angle center.
Brocas de centrar 90°
Punte a centrare 90°

Pointage / Spotting / Punteado / Centratura NC

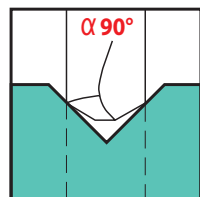
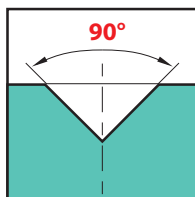

90° :
En utilisant le foret **NC magafor** de diamètre supérieur à l'outil de perçage, on obtiendra centrage et chanfreinage en une seule opération.
By using the **magafor NC** drill of diameter over the drilling tool, centering and chamfering are obtained in a single operation.
Obtendrá un centrado y avellanado en una sola operación.
Si otterrà la centratura e lo smusso in un'unica operazione.

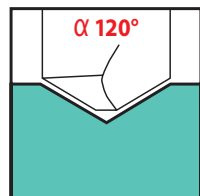
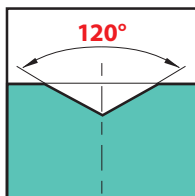

120°:
L'avant-trou obtenu par le Foret **NC magafor** correspond à l'angle en bout de l'outil de perçage et évite à celui-ci de dévier.
The preliminary hole obtained with the **magafor NC** drill corresponds to the angle of the end of the tool used in drilling and prevents it from deviating.
El agujero previo obtenido corresponde al ángulo de la punta de la herramienta utilizada para taladrar y previene su desvío.
L'avanforo realizzato corrisponde all'angolo di affilatura dell'utensile a forare impedendo a quest'ultimo di deviare.

performances

Recommendations
Recomendación
Suggerimento

N° 1

N° 2

Autres
Others
Otro
Altre
soluzioni

Vc = vitesse speed velocidad velocità: m/min.

Vf = avance feed avance avanzamento: mm/min.

$\frac{Vc \times 1000}{\pi \times \varnothing}$ Tours par min. Rev. / min.
Giri / min. revoluciones por minuto.

Conditions d'utilisation des forets à centrer et NC Recommendations for the use of NC and center drills

Condiciones de corte para brocas de centrar y CNC

Condizioni di impiego delle punte a centrare ed NC

Matière Material <i>Material</i>		HSS	HSS Co	HSS-Co + TiN	HSS 8% Co	HSS 8% Co + Red'X	Carbure Carbide Metallo Duro	Carbure Carbide + Hard'X
P	Aciers / Steels <i>Aceros / Acciai</i> ≤ 500 N/mm ²	Vc	30~35	35~45	45~55	45~55	45~60	
		Ø 2 - 3	0,08 - 0,10	0,08 - 0,10	0,08 - 0,10	0,08 - 0,10	0,08 - 0,10	
		Ø 6 - 10	0,15 - 0,25	0,15 - 0,25	0,15 - 0,25	0,15 - 0,25	0,15 - 0,25	
	Aciers / Steels <i>Aceros / Acciai</i> 500 ~ 800 N/mm ²	Vc	20~25	30~40	40~50	45~50	40~55	
		Ø 2 - 3	0,08 - 0,10	0,08 - 0,10	0,08 - 0,10	0,08 - 0,10	0,08 - 0,10	
		Ø 6 - 10	0,15 - 0,25	0,15 - 0,25	0,15 - 0,25	0,15 - 0,25	0,15 - 0,25	
	Aciers / Steels <i>Aceros / Acciai</i> 800 ~ 1000 N/mm ²	Vc	15~25	25~35	35~45	35~50	35~50	40~55
		Ø 2 - 3	0,05 - 0,07	0,05 - 0,07	0,05 - 0,07	0,05 - 0,07	0,05 - 0,07	0,07 - 0,09
		Ø 6 - 10	0,14 - 0,20	0,14 - 0,20	0,14 - 0,20	0,14 - 0,20	0,14 - 0,20	0,15 - 0,22
M	Inox / Stainless steel <i>Aceros Inoxidables</i> 1000 ~ 1300 N/mm ²	Vc	6~10	10~15	15~20	20~25	20~25	25~40
		Ø 2 - 3	0,04 - 0,06	0,04 - 0,06	0,04 - 0,06	0,04 - 0,06	0,04 - 0,06	0,06 - 0,08
		Ø 6 - 10	0,12 - 0,18	0,12 - 0,18	0,12 - 0,18	0,12 - 0,18	0,12 - 0,18	0,15 - 0,22
H	Acier anti-abrasion / tough Steel <i>Acero resistente a la abrasión</i> < 420 HB	Vc		8~10	12~15	15~25	15~25	25~30
		Ø 2 - 3		0,04 - 0,06	0,04 - 0,06	0,04 - 0,06	0,04 - 0,06	0,06 - 0,08
		Ø 6 - 10		0,12 - 0,15	0,12 - 0,15	0,12 - 0,15	0,12 - 0,15	0,17 - 0,17
S	Bronze dur Inconel, Nimonic Hard bronze <i>Bronce / Bronzo duro</i>	Vc		5~6	8~10	10~15	15~20	20~30
		Ø 2 - 3		0,03 - 0,04	0,03 - 0,04	0,03 - 0,04	0,03 - 0,04	0,05 - 0,06
		Ø 6 - 10		0,06 - 0,12	0,06 - 0,12	0,06 - 0,12	0,06 - 0,12	0,08 - 0,15
H	Acier traité / Treated steel <i>Acero tratado / Acciai trattati</i> ≥ 60 HRC	Vc					10~15	10~15
		Ø 2 - 3					0,04 - 0,05	0,04 - 0,05
		Ø 6 - 10					0,06 - 0,10	0,06 - 0,10
K	Fonte / Cast iron <i>Fundición / Ghisa</i>	Vc	15~20	20~30	30~40	30~45	35~45	45~50
		Ø 2 - 3	0,08 - 0,10	0,08 - 0,10	0,08 - 0,10	0,08 - 0,10	0,08 - 0,10	0,10 - 0,12
		Ø 6 - 10	0,15 - 0,20	0,15 - 0,20	0,15 - 0,20	0,15 - 0,20	0,15 - 0,20	0,17 - 0,25
N	Aluminium <i>Alluminio</i>	Vc	60~80	70~80	80~90	85~95	85~100	100~110
		Ø 2 - 3	0,10 - 0,12	0,10 - 0,12	0,10 - 0,12	0,10 - 0,12	0,10 - 0,12	0,12 - 0,14
		Ø 6 - 10	0,15 - 0,20	0,15 - 0,20	0,15 - 0,20	0,15 - 0,20	0,15 - 0,20	0,17 - 0,25
	Laiton / Brass <i>Latón / Ottone</i> Bronze / Bronze <i>Bronce / Bronzo</i>	Vc	30~35	35~45	45~50	45~55	45~55	55~60
		Ø 2 - 3	0,08 - 0,10	0,08 - 0,10	0,08 - 0,10	0,08 - 0,10	0,08 - 0,10	0,10 - 0,12
		Ø 6 - 10	0,15 - 0,20	0,15 - 0,20	0,15 - 0,20	0,15 - 0,20	0,15 - 0,20	0,17 - 0,25
	Cuiivre / Copper <i>Cobre / Rame</i>	Vc	40~50	45~55	55~60	55~60	55~65	65~70
		Ø 2 - 3	0,08 - 0,10	0,08 - 0,10	0,08 - 0,10	0,08 - 0,10	0,08 - 0,10	0,10 - 0,12
		Ø 6 - 10	0,15 - 0,20	0,15 - 0,20	0,15 - 0,20	0,15 - 0,20	0,15 - 0,20	0,17 - 0,25
Stratifié / Laminated <i>Laminados / Laminati</i>	Vc	35~40	40~50	50~55	50~60	50~60	60~65	
	Ø 2 - 3	0,12 - 0,14	0,12 - 0,14	0,12 - 0,14	0,12 - 0,14	0,12 - 0,14	0,15 - 0,16	
	Ø 6 - 10	0,20 - 0,25	0,20 - 0,25	0,20 - 0,25	0,20 - 0,25	0,20 - 0,25	0,25 - 0,30	
Nylon PVC / Plastics <i>Plásticos / Plastiche</i>	Vc	50~80	60~100	70~120	80~130	80~130	150~200	
	Ø 2 - 3	0,12 - 0,14	0,12 - 0,14	0,12 - 0,14	0,12 - 0,14	0,12 - 0,14	0,15 - 0,16	
	Ø 6 - 10	0,20 - 0,25	0,20 - 0,25	0,20 - 0,25	0,20 - 0,25	0,20 - 0,25	0,25 - 0,30	
	Ø 16	Vc	0,30	0,30	0,30	0,30	0,30	0,35





Forets à centrer • Center drills

Brocas de centrar • Punta a centrare

60° Forme A • Form A • Forma A

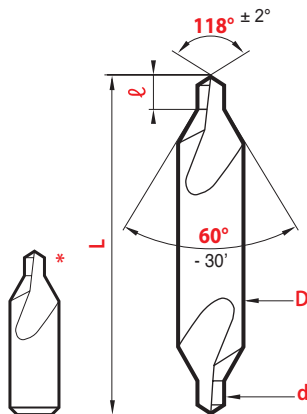
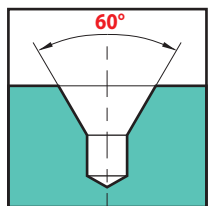

Le foret à centrer 60° norme ISO est le type le plus universel. **Magafor** en offre huit qualités couvrant tous les cas d'usinage.

The ISO standard 60° center drill is the most universal type. **Magafor** offers eight different options to answer all machining needs.

La broca de centrar norma ISO 60° es el tipo más universal. **Magafor** ofrece ocho calidades cubriendo todos los casos de mecanizado.

La punta a centrare a 60° a norma ISO rappresenta la tipologia universale. **Magafor** ne offre otto qualità per coprire tutte le necessità di lavorazione.

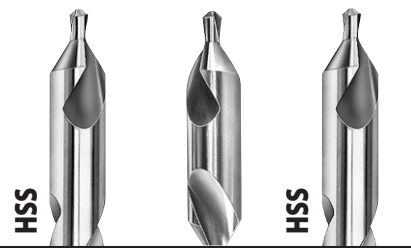

ISO • NFE 66051-A
DIN 333-A • JIS-1

Type Tipo	L		ℓ		magafor 11	magafor 16	Classic 03
D x d	h7	k12	± 1	mini	maxi		
3,0 x 0,5	31			0,6	~ 0,9	11,80 €	
3,15 x 0,5*	25			0,6	~ 0,9	5,71 €	8,87 €
3,15 x 0,63*	25			0,7	~ 1,0	5,71 €	8,87 €
3,15 x 0,8*	25			1,0	~ 1,3	5,71 €	8,87 €
3,15 x 1,0	31			1,3	~ 1,7	5,71 €	8,87 €
3,15 x 1,25	31			1,6	~ 2,0	5,71 €	8,87 €
3,5 x 0,75	35			1,0	~ 1,3	6,69 €	10,94 €
4,0 x 1,0	35			1,3	~ 1,7	5,96 €	10,94 €
4,0 x 1,25	35			1,6	~ 2,0	5,96 €	10,94 €
4,0 x 1,6	35			2,0	~ 2,6	5,96 €	9,00 €
5,0 x 1,5	40			2,0	~ 2,6	6,46 €	11,55 €
5,0 x 1,6	40			2,0	~ 2,6	6,69 €	11,55 €
5,0 x 2,0	40			2,5	~ 3,1	6,46 €	9,85 €
6,0 x 2,0	45			2,5	~ 3,1	7,18 €	13,06 €
6,3 x 2,0	45			2,5	~ 3,1	7,42 €	13,06 €
6,3 x 2,5	45			3,1	~ 3,8	7,18 €	11,08 €
8,0 x 2,5	50			3,1	~ 3,8	8,28 €	15,50 €
8,0 x 3,0	50			3,9	~ 4,6	8,28 €	15,50 €
8,0 x 3,15	50			3,9	~ 4,6	8,28 €	13,37 €
10,0 x 3,0	55			3,9	~ 4,6	10,71 €	20,68 €
10,0 x 3,15	55			3,9	~ 4,6	10,82 €	20,68 €
10,0 x 4,0	55			5,0	~ 5,9	10,71 €	17,63 €
12,0 x 4,0	63			5,0	~ 5,9	17,94 €	29,18 €
12,0 x 5,0	63			6,3	~ 7,2	17,94 €	29,18 €
12,5 x 4,0	63			5,0	~ 5,9	18,24 €	29,18 €
12,5 x 5,0	63			6,3	~ 7,2	17,94 €	26,15 €
14,0 x 5,0	69			6,3	~ 7,2	23,42 €	43,78 €
16,0 x 5,0	71			6,3	~ 7,2	26,75 €	54,73 €
16,0 x 6,3	71			8,0	~ 8,9	25,84 €	49,25 €
18,0 x 6,0	77			8,0	~ 8,9	37,69 €	
20,0 x 6,3	80			8,0	~ 8,9	51,68 €	
20,0 x 8,0	80			10,1	~ 11,1	48,64 €	85,73 €
25,0 x 8,0	100			10,1	~ 11,1	86,35 €	
25,0 x 10,0	100			12,8	~ 13,8	86,35 €	
31,5 x 10,0	125			12,8	~ 13,8	203,10 €	
31,5 x 12,5	125			16,5	~ 17,5	197,01 €	

*D'un seul côté Single end De una sola punta Ad un solo lato



Promo-kits 30

Quantité Cantidad	Quantity Quantità	magafor 110/1	magafor 110/2
5 pièces de chaque Ø		1,0 x 3,15	0,5 x 3,0
5 pieces of each Ø		1,6 x 4,0	1,0 x 4,0
5 piezas de cada Ø		2,0 x 5,0	1,5 x 5,0
5 pezzi per ogni Ø		2,5 x 6,3	2,0 x 6,0
		3,15 x 8,0	2,5 x 8,0
4 pieces	piezza pezzi	4,0 x 10,0	3,0 x 10,0
1 piece	piezza pezzo	5,0 x 12,5	4,0 x 12,0
		217,69 €	217,69 €

Promo-kits 15

Quantité Cantidad	Quantity Quantità	magafor 110/3	magafor 110/4
3 pièces de chaque Ø		1,0 x 4,0	1,6 x 4,0
3 pieces of each Ø		1,5 x 5,0	2,0 x 5,0
3 piezas de cada Ø		2,0 x 6,0	2,5 x 6,3
3 pezzi per ogni Ø		2,5 x 8,0	3,15 x 8,0
		3,0 x 10,0	4,0 x 10,0
2 pièces	piezza pezzi	4,0 x 12,0	5,0 x 12,5
1 pièce	piezza pezzo	5,0 x 12,5	4,0 x 12,0
		120,39 €	120,39 €



ISO • NFE 66051-A
DIN 333-A • JIS-1

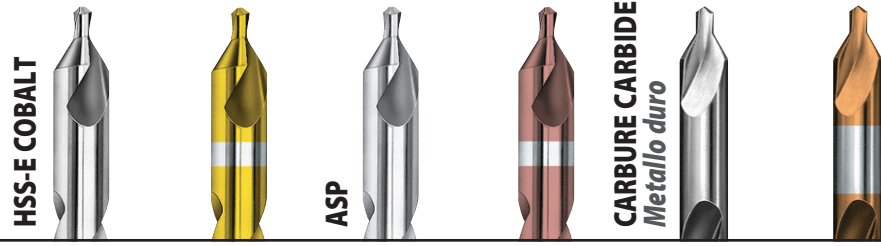

D x d h7 ⁽¹⁾ k12	L ± 1	ℓ mini maxi	magafor 10	TIN 0811	magafor 105	Red'X 0910	magaforce 8100	Hard'X 8100-H
3,15 x 0,5 ⁽²⁾	25	0,6 ~ 0,9	8,02 €	13,26 €	12,77 €	24,68 €	41,34 €	46,82 €
3,15 x 0,6 ⁽²⁾	25	0,6 ~ 0,9					41,34 €	46,82 €
3,15 x 0,8 ⁽²⁾	25	1,0 ~ 1,3	8,02 €	13,26 €			41,34 €	46,82 €
3,15 x 1,0	31	1,3 ~ 1,7	8,02 €	13,26 €	12,77 €	21,90 €	42,56 €	49,25 €
3,15 x 1,25	31	1,6 ~ 2,0	8,02 €	13,26 €	12,77 €	21,90 €	42,56 €	49,25 €
3,5 x 0,75	35	1,0 ~ 1,3	8,76 €	14,60 €				
4,0 x 1,0	35	1,3 ~ 1,7	8,15 €	13,37 €			43,78 €	50,47 €
4,0 x 1,6	35	2,0 ~ 2,6	8,15 €	13,37 €	12,89 €	22,49 €	43,78 €	50,47 €
5,0 x 1,5	40	2,0 ~ 2,6	9,00 €	14,23 €			54,73 €	62,02 €
5,0 x 2,0	40	2,5 ~ 3,1	9,00 €	14,23 €	13,49 €	23,42 €	54,73 €	62,02 €
6,0 x 2,0	45	2,5 ~ 3,1	10,22 €	16,18 €			65,07 €	74,18 €
6,3 x 2,5	45	3,1 ~ 3,8	10,22 €	16,18 €	16,05 €	26,46 €	65,07 €	74,18 €
8,0 x 2,5	50	3,1 ~ 3,8	11,67 €	18,36 €			79,04 €	90,00 €
8,0 x 3,0	50	3,9 ~ 4,6	11,67 €	18,36 €			79,04 €	90,00 €
8,0 x 3,15	50	3,9 ~ 4,6	11,67 €	18,36 €	18,36 €	30,71 €	79,04 €	90,00 €
10,0 x 3,0	55	3,9 ~ 4,6	14,89 €	24,20 €			105,19 €	119,19 €
10,0 x 4,0	55	5,0 ~ 5,9	14,89 €	24,20 €	24,02 €	39,52 €	105,19 €	119,19 €
12,0 x 4,0	63	5,0 ~ 5,9	24,02 €	41,23 €				
12,0 x 5,0	63	6,3 ~ 7,2	24,02 €	41,23 €			177,56 €	194,58 €
12,5 x 5,0	63	6,3 ~ 7,2	24,02 €	41,23 €	39,82 €	60,21 €	177,56 €	194,58 €
14,0 x 5,0	69	6,3 ~ 7,2	32,83 €	52,61 €				
16,0 x 6,3	71	8,0 ~ 8,9	43,78 €	62,64 €			280,92 €	301,61 €
20,0 x 8,0	80	10,1 ~ 11,1	91,83 €	112,50 €				
25,0 x 10,0	100	12,8 ~ 13,8	155,06 €	179,39 €				

(1) CARBURE CARBIDE METAL DURO METALLO DURO = h5 (2) Un seul côté Single end De una sola punta Ad un solo lato

magafor *Le choix! The choice! La elección! La scelta!*

Matière Material Materiale	HSS	HSS-E COBALT	HSS-E COBALT + TIN	ASP	ASP + Red'X	CARBURE VHM Metallo duro	CARBURE VHM + Hard'X
Dureté Hardness Durezza	63 HRC	65 HRC	65 HRC + 2300 HV	67 HRC	67 HRC + 3500 HV	1800 HV	1800 HV + 3500 HV
Utilisation Use Utilización Impiego	Petites séries Small series Pequeñas series Piccole serie	Production intensive Intensive production Producción intensiva Produzione intensiva		Alliages durs et abrasifs Hard and abrasive alloys Aleaciones duras y abrasivos Leghe dure e abrasive		Aciers trempés Treated steels Aceros tratados Acciai temprati	



Emballage Packaging
Embalaje Imballo
magafor 10-11 Classic 03
10 pièces piezas pezzi D x d ≤ 10 x 4

Avec plat
With flat
Con plano
Con piano

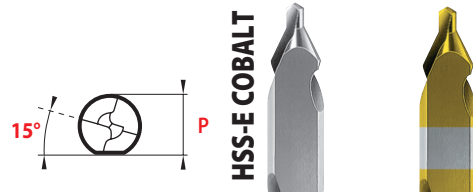

D x d h7 k12	L ± 1	ℓ mini maxi	P -0,1	magafor 0290	TIN 0890
4,0 x 1,6	35	2,0 ~ 2,6	3,25	9,23 €	14,48 €
5,0 x 2,0	40	2,5 ~ 3,1	4,2	10,34 €	16,05 €
6,3 x 2,5	45	3,1 ~ 3,8	5,35	11,31 €	17,87 €
8,0 x 3,15	50	3,9 ~ 4,6	6,95	13,68 €	20,36 €
10,0 x 4,0	55	5,0 ~ 5,9	8,4	21,40 €	31,02 €
12,5 x 5,0	63	6,3 ~ 7,2	10,95	29,18 €	47,42 €
16,0 x 6,3	71	8,0 ~ 8,9	14	47,42 €	66,27 €
20,0 x 8,0	80	10,1 ~ 11,1	17,9	74,79 €	
25,0 x 10,0	100	12,8 ~ 13,8	22,5	131,34 €	



Forets à centrer • Center drills

Brocas de centrar • Punte a centrare

60°

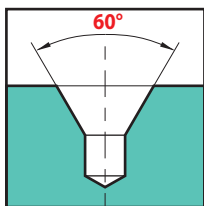

Tolérances Tolerancias Tolleranze

D	d	α	
		60°	118°
h7	0,5 ~ 1,5 ± 0,05	- 30'	± 2°
	2,0 ~ 4,0 ± 0,08		
	5,0 ~ 6,0 ± 0,12		



Emballage Packaging

Embalaje Imballo

magafor 117-118

10 pièces piezas pezzi D x d ≤ 10 x 4



D x d	L ± 1	ℓ mini maxi	magafor 117	magafor 118	TIN 0818
3,0 x 0,5	31	0,6 ~ 0,9		11,93 €	16,05 €
4,0 x 0,8	35	0,9 ~ 1,3		8,15 €	12,16 €
4,0 x 1,0	35	1,2 ~ 1,5	5,89 €	6,56 €	10,58 €
5,0 x 1,2	40	1,3 ~ 1,8	6,56 €	7,30 €	11,31 €
5,0 x 1,5*	40	1,5 ~ 2,0	6,56 €	7,30 €	11,31 €
5,0 x 1,5*	42	1,8 ~ 2,4		7,30 €	
5,0 x 2,0*	40	2,0 ~ 2,5	6,56 €		
5,0 x 2,0*	42	2,4 ~ 3,0		7,30 €	
6,0 x 2,0	45	2,0 ~ 2,5	7,45 €	8,28 €	13,01 €
6,0 x 2,5*	45	3,1 ~ 3,8	7,87 €	8,76 €	13,49 €
6,0 x 2,5*	47	3,0 ~ 3,7		8,76 €	
7,7 x 2,5*	50	2,5 ~ 3,0		9,85 €	16,54 €
7,7 x 2,5*	57	2,5 ~ 3,0	8,85 €	9,85 €	16,54 €
7,7 x 3,0	57	3,0 ~ 3,6	8,85 €	9,85 €	16,54 €
7,7 x 3,2	57	3,2 ~ 3,8	8,85 €	9,85 €	16,54 €
8,0 x 3,0*	50	3,9 ~ 4,6	9,68 €	10,77 €	17,46 €
8,0 x 3,0*	53	3,8 ~ 4,5		10,77 €	
8,0 x 3,2	50	3,9 ~ 4,6	9,68 €	10,77 €	17,46 €
10,0 x 4,0*	65	4,5 ~ 5,1	10,29 €	11,43 €	20,74 €
10,0 x 4,0*	69	4,5 ~ 5,1	11,76 €	13,06 €	21,65 €
11,0 x 4,0	69	4,5 ~ 5,1	18,62 €	20,68 €	37,88 €
11,0 x 5,0*	69	5,5 ~ 6,1	18,62 €	20,68 €	37,88 €
11,0 x 5,0*	78	5,5 ~ 6,1	20,26 €	22,49 €	39,72 €
16,0 x 6,0	90	7,0 ~ 8,0	38,30 €	42,56 €	57,77 €
18,0 x 6,0	95	7,0 ~ 8,0	41,59 €	46,22 €	63,85 €

*Préciser la longueur totale L
Precisar la longitud total L

Overall length L has to be mentioned
Precisare la lunghezza totale L



Hors normes

No normalized standard

Fuera de normas

Misure non

normalizzate

magafor standard

D x d	L ± 1	ℓ mini maxi	magafor 110	D x d	L ± 1	ℓ mini maxi	magafor 110
2,0 x 0,5	31	0,6 ~ 0,9	36,65 €	8,0 x 2,0	50	2,5 ~ 3,1	22,49 €
2,0 x 0,75	31	1,0 ~ 1,3	33,75 €	8,0 x 3,5	50	4,4 ~ 5,1	22,49 €
2,5 x 0,75	31	1,0 ~ 1,3	33,75 €	8,0 x 4,0	50	5,0 ~ 5,9	22,49 €
3,0 x 0,3	31	0,3 ~ 0,4	36,65 €	10,0 x 2,0	55	2,5 ~ 3,1	26,15 €
3,0 x 0,4	31	0,5 ~ 0,7	36,65 €	10,0 x 2,5	55	3,1 ~ 3,8	26,15 €
3,0 x 0,75	31	1,0 ~ 1,3	18,24 €	10,0 x 3,5	55	4,4 ~ 5,1	26,15 €
3,0 x 1,0	31	1,3 ~ 1,7	18,24 €	10,0 x 5,0	55	6,3 ~ 7,2	26,15 €
3,5 x 0,5	35	0,6 ~ 0,9	18,24 €	12,0 x 2,5	63	3,1 ~ 3,8	41,34 €
4,0 x 0,75	35	1,0 ~ 1,3	18,24 €	12,0 x 3,0	63	3,9 ~ 4,6	41,34 €
4,0 x 1,5	35	2,0 ~ 2,6	18,24 €	12,0 x 3,5	63	4,4 ~ 5,1	41,34 €
4,0 x 2,0	35	2,5 ~ 3,1	18,24 €	12,0 x 6,0	63	8,0 ~ 8,9	41,34 €
5,0 x 1,0	40	1,3 ~ 1,7	18,24 €	14,0 x 3,0	69	3,9 ~ 4,6	60,21 €
5,0 x 2,5	40	3,1 ~ 3,8	18,24 €	14,0 x 4,0	69	5,0 ~ 5,9	60,21 €
6,0 x 1,0	45	1,3 ~ 1,7	18,24 €	14,0 x 6,0	69	8,0 ~ 8,9	60,21 €
6,0 x 1,5	45	2,0 ~ 2,6	18,24 €	16,0 x 4,0	71	5,0 ~ 5,9	76,61 €
6,0 x 2,5	45	3,1 ~ 3,8	18,24 €	16,0 x 6,0	71	8,0 ~ 8,9	76,61 €
6,0 x 3,0	45	3,9 ~ 4,6	18,24 €	18,0 x 5,0	77	6,3 ~ 7,2	96,69 €
7,0 x 2,5	50	3,1 ~ 3,8	22,49 €	20,0 x 7,0	80	9,0 ~ 9,9	150,81 €
7,5 x 2,5	50	3,1 ~ 3,8	22,49 €	22,0 x 6,0	100	8,0 ~ 8,9	232,28 €
8,0 x 1,5	50	2,0 ~ 2,6	22,49 €				

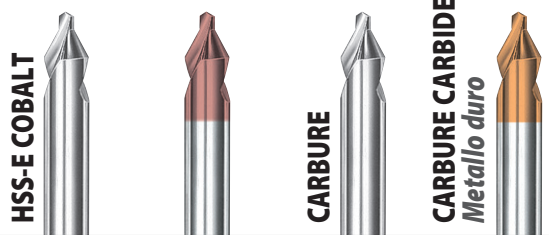

60° Longs et extra-longs

Long reach series

Largas y extra-largas

Serie lunga ed extra lunga

magafor standard

L ⁽¹⁾	D x d	ℓ	magafor 18	Red'X 0918	magaforce 8118	Hard'X 8118-H
± 1	h7 ⁽²⁾ k12	mini maxi				
60	3,5 x 0,75	1,0 ~ 1,3	12,16 €			
	4,0 x 1,0	1,3 ~ 1,7	12,04 €			
	5,0 x 1,5	2,0 ~ 2,6	11,67 €			
80	6,0 x 2,0	2,5 ~ 3,1	12,47 €			
	8,0 x 2,5	3,1 ~ 3,8	15,80 €			
	8,0 x 3,0	3,9 ~ 4,6	15,80 €			
100	4,0 x 1,0	1,3 ~ 1,7	21,28 €	36,00 €	102,00 €	108,93 €
	5,0 x 1,5	2,0 ~ 2,6	20,68 €			
	6,0 x 2,0	2,5 ~ 3,1	20,68 €	38,35 €	105,00 €	115,53 €
	8,0 x 2,5	3,1 ~ 3,8	20,68 €			
	8,0 x 3,0	3,9 ~ 4,6	20,68 €	39,52 €	146,00 €	158,10 €
	10,0 x 3,0	3,9 ~ 4,6	20,68 €			
	10,0 x 4,0	5,0 ~ 5,9	20,68 €	41,34 €	192,00 €	206,74 €
	12,0 x 4,0	5,0 ~ 5,9	27,67 €			
120	12,0 x 5,0	6,3 ~ 7,2	27,67 €			
	3,5 x 0,75	1,0 ~ 1,3	39,52 €			
	4,0 x 1,0	1,3 ~ 1,7	28,28 €			
	5,0 x 1,5	2,0 ~ 2,6	27,67 €			
	5,0 x 1,6	2,0 ~ 2,6	27,67 €			
	6,0 x 2,0	2,5 ~ 3,1	27,67 €			
	8,0 x 2,5	3,1 ~ 3,8	32,23 €			
	8,0 x 3,0	3,9 ~ 4,6	32,23 €			
	10,0 x 3,0	3,9 ~ 4,6	37,09 €			
	10,0 x 3,15	3,9 ~ 4,6	37,09 €			
150	10,0 x 4,0	5,0 ~ 5,9	37,09 €			
	12,0 x 4,0	5,0 ~ 5,9	44,99 €			
	14,0 x 5,0	6,3 ~ 7,2	55,33 €			
	4,0 x 1,0	1,3 ~ 1,7	33,44 €			
	5,0 x 1,5	2,0 ~ 2,6	33,44 €			
	6,0 x 2,0	2,5 ~ 3,1	33,44 €			
	8,0 x 2,5	3,1 ~ 3,8	38,31 €			
	8,0 x 3,0	3,9 ~ 4,6	38,31 €			
200	10,0 x 3,0	3,9 ~ 4,6	43,78 €			
	10,0 x 4,0	5,0 ~ 5,9	43,78 €			
	12,0 x 4,0	5,0 ~ 5,9	53,51 €			
	16,0 x 6,3	8,0 ~ 8,9	79,04 €			
	5,0 x 2,0	2,5 ~ 3,1	69,93 €			
	6,3 x 2,5	3,1 ~ 3,8	68,71 €			
200	8,0 x 3,15	3,9 ~ 4,6	65,07 €			
	10,0 x 4,0	5,0 ~ 5,9	71,14 €			

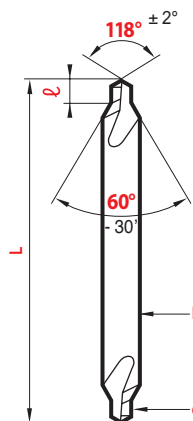
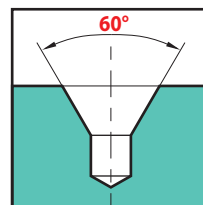

Hard-X

Jusqu'à

up to

Hasta

Fino a 67 HRC

(1) Si "L" non indiquée: livraison en longueur 100 mm
When "L" is not mentioned: 100 mm overall will be delivered
Si no se especifica "L": entrega con longitud de 100mm
Se "L" non viene indicata: consegna in lunghezza 100 mm

(2) CARBURE CARBIDE METAL DURO METALLO DURO = h5

promo-kits

HSS-Co

6 pièces pieces piezza pezzi		magafor 180
4 x 1 L 60	5 x 1,5 L 60	
6 x 2 L 80	8 x 2,5 L 80	96,07 €
10 x 3 L 100	12 x 4 L 100	





Forets à centrer • Center drills

Brocas de centrar • Punte a centrare

Cotes en pouces

Sizes in inches

Medidas en pulgadas

Misure in pollici

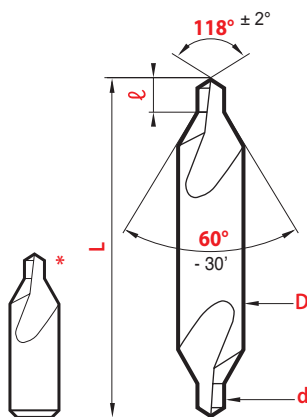
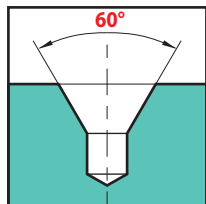

Emballage Packaging

Embalaje Imballo

magafor 114-115

10 pièces piezas pezzi D x d ≤ 10 x 4

A N° 00000 ~ 5



60°

HSS



HSS-E 8% COBALT



ASA N°	D x d h7 k12	L ± 1	ℓ mini maxi	magafor 115	TIN 08115	magafor 1055	Red'X 0915
Forets d'un seul côté* Single end drills				Brocas de una sola punta Punte ad un solo lato			
A 00000	3,17 x 0,25 (1/8 x .010)	31	0,2 ~ 0,45	24,93 €	29,80 €	27,67 €	38,31 €
B 0000	3,17 x 0,38 (1/8 x .015)	31	0,35 ~ 0,65	18,55 €	23,47 €	20,68 €	32,84 €
C 000	3,17 x 0,51 (1/8 x .020)	31	0,5 ~ 0,8			18,55 €	31,02 €
D 00	3,17 x 0,63 (1/8 x .025)	31	0,7 ~ 1,0			17,33 €	27,36 €
E 0	3,17 x 0,79 (1/8 x 1/32)	31	0,9 ~ 1,2			14,89 €	24,33 €
Forets doubles Double end drills				Brocas de doble punta Punte doppie			
C 000	3,17 x 0,51 (1/8 x .020)	31	0,5 ~ 0,8	13,37 €	18,85 €		
D 00	3,17 x 0,63 (1/8 x .025)	31	0,7 ~ 1,0	10,34 €	15,57 €		
E 0	3,17 x 0,79 (1/8 x 1/32)	31	0,9 ~ 1,2	6,69 €	11,92 €		
F 1/0	3,17 x 1,02 (1/8 x .040)	31	1,0 ~ 1,3	6,69 €	11,92 €	17,33 €	
1	3,17 x 1,19 (1/8 x 3/64)	31	1,4 ~ 1,7	5,96 €	11,31 €	11,43 €	22,98 €
2	4,76 x 1,98 (3/16 x 5/64)	47	2,4 ~ 2,7	6,20 €	11,67 €	12,16 €	23,83 €
3	6,35 x 2,77 (1/4 x 7/64)	50	3,3 ~ 3,9	7,18 €	13,49 €	13,68 €	25,54 €
4	7,93 x 3,17 (5/16 x 1/8)	54	3,8 ~ 4,4	8,15 €	14,96 €	15,80 €	27,36 €
4-1/2	9,52 x 3,57 (3/8 x 9/64)	63	4,3 ~ 4,9	11,67 €	21,90 €	23,11 €	
5	11,11 x 4,76 (7/16 x 3/16)	70	5,9 ~ 6,5	14,89 €	28,82 €	29,49 €	34,06 €
6	12,70 x 5,55 (1/2 x 7/32)	76	6,9 ~ 7,5	17,94 €	31,98 €	34,06 €	51,39 €
7	15,87 x 6,35 (5/8 x 1/4)	82	8,0 ~ 8,6	25,84 €	58,98 €	50,47 €	74,18 €
8	19,05 x 7,93 (3/4 x 5/16)	89	10,0 ~ 10,6	47,42 €	108,23 €	95,46 €	138,65 €
9	22,22 x 8,73 (7/8 x 11/32)	92	11,0 ~ 11,6	63,24 €	144,71 €	133,78 €	
10	25,40 x 9,52 (1 x 3/8)	95	12,1 ~ 12,7	79,04 €	181,20 €	170,27 €	



60°

CARBURE CARBIDE

METAL DURO METALLO DURO

ASA N°	D x d h5 k12	L ± 1	ℓ mini maxi	magaforce 8105	Hard'X 8105-H
D 00	3,17 x 0,63 (1/8 x .025)	31	0,7 ~ 1,0	54,73 €	62,64 €
E 0	3,17 x 0,79 (1/8 x .020)	31	0,9 ~ 1,2	48,64 €	56,55 €
1	3,17 x 1,19 (1/8 x 3/64)	31	1,4 ~ 1,7	42,56 €	50,47 €
2	4,76 x 1,98 (3/16 x 5/64)	47	2,4 ~ 2,7	54,73 €	62,02 €
3	6,35 x 2,77 (1/4 x 7/64)	50	3,3 ~ 3,9	66,89 €	76,01 €
4	7,93 x 3,17 (5/16 x 1/8)	54	3,8 ~ 4,4	79,04 €	90,00 €
5	11,11 x 4,76 (7/16 x 3/16)	70	5,9 ~ 6,5	152,03 €	166,61 €
6	12,70 x 5,55 (1/2 x 7/32)	76	6,9 ~ 7,5	194,58 €	211,61 €





82°-90°

HSS

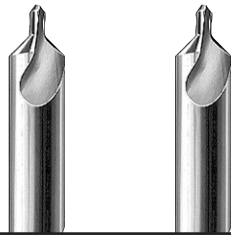

60°

HSS



ASA N°	D x d h7 k12	L ± 1	ℓ mini maxi	82° 154	90° 155
1	3,17 x 1,19 (1/8 x 3/64)	31	1,4 ~ 1,7	14,29 €	14,29 €
2	4,76 x 1,98 (3/16 x 5/64)	47	2,4 ~ 2,7	13,68 €	13,68 €
3	6,35 x 2,77 (1/4 x 7/64)	50	3,3 ~ 3,9	16,43 €	16,43 €
4	7,93 x 3,17 (5/16 x 1/8)	54	3,8 ~ 4,4	19,15 €	19,15 €
5	11,11 x 4,76 (7/16 x 3/16)	70	5,9 ~ 6,5	36,49 €	36,49 €
6	12,70 x 5,55 (1/2 x 7/32)	76	6,9 ~ 7,5	40,13 €	40,13 €
7	15,87 x 6,35 (5/8 x 1/4)	82	8,0 ~ 8,6	66,27 €	66,27 €
8	19,05 x 7,93 (3/4 x 5/16)	89	10,0 ~ 10,6	83,91 €	83,91 €

BS N°	D x d h7 k12	L ± 1	ℓ mini maxi	magafor 114
1	3,17 x 1,19 (1/8 x 3/64)	38	1,5 ~ 1,8	5,96 €
2	4,76 x 1,58 (3/16 x 1/16)	44	2,0 ~ 2,4	6,20 €
3	6,35 x 2,38 (1/4 x 3/32)	50	3,3 ~ 3,9	7,18 €
4	7,93 x 3,17 (5/16 x 1/8)	56	4,1 ~ 4,7	8,28 €
5	11,11 x 4,76 (7/16 x 3/16)	63	6,5 ~ 7,1	14,89 €
6	15,87 x 6,35 (5/8 x 1/4)	75	8,5 ~ 9,1	25,84 €
7	19,05 x 7,93 (3/4 x 5/16)	89	10,8 ~ 11,6	47,42 €

Longs

Largas
Serie lunga



60°-82°-90°

HSS



HSS-E COBALT



HSS



HSS



ASA N°	D x d h7 k12	L ± 1	60° 185	60° 186	82° 154-L	90° 155-L
1 x 3"		76	11,31 €	14,14 €	20,06 €	20,06 €
1 x 4"	3,17 x 1,19	102	21,28 €	26,61 €	37,69 €	37,69 €
1 x 5"	(1/8 x 3/64)	127	28,28 €	35,34 €	49,85 €	49,85 €
1 x 6"		152	31,62 €	39,52 €	54,73 €	54,73 €
2 x 3"		76	12,16 €	15,20 €	21,28 €	21,28 €
2 x 4"	4,76 x 1,98	102	19,77 €	24,69 €	34,65 €	34,65 €
2 x 5"	(3/16 x 5/64)	127	27,36 €	34,20 €	48,05 €	48,05 €
2 x 6"		152	31,02 €	38,56 €	55,95 €	55,95 €
3 x 3"		76	12,47 €			
3 x 4"	6,35 x 2,77	102	19,77 €	24,69 €	35,27 €	35,27 €
3 x 5"	(1/4 x 7/64)	127	27,67 €	34,20 €	51,08 €	51,08 €
3 x 6"		152	31,02 €	38,56 €	57,77 €	57,77 €
4 x 3"		76	13,06 €			
4 x 4"	7,93 x 3,17	102	20,68 €	25,84 €	36,49 €	36,49 €
4 x 5"	(5/16 x 1/8)	127	32,23 €	40,28 €	57,77 €	57,77 €
4 x 6"		152	35,87 €	44,85 €	63,24 €	63,24 €
4-1/2 x 4"		102	21,90 €			
4-1/2 x 5"	9,52 x 3,57	127	37,09 €			
4-1/2 x 6"	(3/8 x 9/64)	152	41,95 €	52,44 €	76,01 €	76,01 €
5 x 4"		102	27,67 €	34,58 €	48,64 €	48,64 €
5 x 5"	11,11 x 4,76	127	44,99 €	56,24 €	79,04 €	79,04 €
5 x 6"	(7/16 x 3/16)	152	49,85 €	62,32 €	87,57 €	87,57 €
6 x 4"		102	28,28 €	35,35 €	51,68 €	51,68 €
6 x 5"	12,70 x 5,55	127	45,61 €	57,01 €	82,10 €	82,10 €
6 x 6"	(1/2 x 7/32)	152	51,08 €	63,85 €	91,21 €	91,21 €
7 x 5"	15,87 x 6,35	127	57,77 €			
7 x 6"	(5/8 x 1/4)	152	66,89 €	83,59 €	103,37 €	103,37 €
8 x 6"	19,05 x 7,93	152	74,18 €	92,73 €	133,78 €	133,78 €
	(3/4 x 5/16)					



Centrage • Pointage / Centering • Spotting
Centratura • Centrate NC / Centrato • Punteado



Forets à centrer • Center drills

Brocas de centrar • Punta a centrare

60°

Avec bourrelet de renfort Forme W With reinforcing bulge Form W

Con refuerzo Forma W

Con refuerzo Forma W

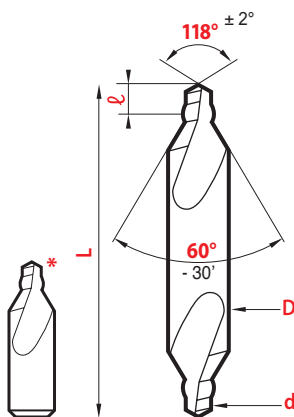
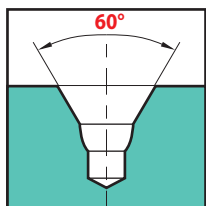

Le foret à centrer **magafor** forme W est plus robuste qu'un foret à centrer normal :

- le bourrelet renforce la pointe,
- il augmente le dégagement des copeaux,
- il favorise la lubrification du foret.

The **magafor** center drill form W is stronger than common center drills :

- the bulge reinforces the point,
- it improves swarf removal,
- it makes the lubrication of the drill easier.

La broca de centrar **magafor** forma W es més robusta que cualquier broca de centrar estándar :

- Punta reforzada,
- Aumento de evacuación de viruta,
- Mejor lubricación de la broca.

La punta a centrare **magafor** forma W è più robusta di una punta a centrare normale :

- il bordino rinforza la punta,
- migliora l'evacuazione dei trucioli,
- favorisce la lubrificazione della punta.

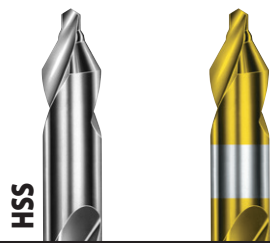

ISO • NFE 66051-W
DIN 333-W • JIS-1

HSS

TIN
0814

D x d	L	ℓ	magafor 14	TIN 0814
h7 k12	± 1	mini maxi		
3,0 x 0,5	31	0,6 ~ 0,9	12,29 €	
3,15 x 0,5*	25	0,6 ~ 0,9	6,08 €	
3,15 x 0,8*	25	1,0 ~ 1,3	6,08 €	
3,15 x 1,0	31	1,3 ~ 1,7	6,08 €	
3,15 x 1,25	31	1,6 ~ 2,0	6,08 €	
4,0 x 1,0	35	1,3 ~ 1,7	6,56 €	12,83 €
4,0 x 1,25	35	1,6 ~ 2,0	6,56 €	
4,0 x 1,6	35	2,0 ~ 2,6	6,56 €	
5,0 x 1,5	40	2,0 ~ 2,6	7,18 €	13,94 €
5,0 x 1,6	40	2,0 ~ 2,6	7,18 €	
5,0 x 2,0	40	2,5 ~ 3,1	7,18 €	
6,0 x 2,0	45	2,5 ~ 3,1	7,90 €	15,20 €
6,3 x 2,0	45	2,5 ~ 3,1	7,90 €	
6,3 x 2,5	45	3,1 ~ 3,8	7,90 €	
8,0 x 2,5	50	3,1 ~ 3,8	8,64 €	16,54 €
8,0 x 3,0	50	3,9 ~ 4,6	8,64 €	
8,0 x 3,15	50	3,9 ~ 4,6	8,64 €	
10,0 x 3,0	55	3,9 ~ 4,6	11,31 €	21,34 €
10,0 x 3,15	55	3,9 ~ 4,6	11,31 €	
10,0 x 4,0	55	5,0 ~ 5,9	11,31 €	
12,0 x 4,0	63	5,0 ~ 5,9	19,15 €	38,31 €
12,0 x 5,0	63	6,3 ~ 7,2	19,15 €	
12,5 x 4,0	63	5,0 ~ 5,9	19,15 €	
12,5 x 5,0	63	6,3 ~ 7,2	19,15 €	
14,0 x 5,0	69	6,3 ~ 7,2	25,54 €	
16,0 x 5,0	71	6,3 ~ 7,2	28,28 €	
16,0 x 6,3	71	8,0 ~ 8,9	28,28 €	
18,0 x 6,0	77	8,0 ~ 8,9	37,09 €	
20,0 x 6,3	80	8,0 ~ 8,9	57,16 €	
20,0 x 8,0	80	10,1 ~ 11,1	57,16 €	
25,0 x 10,0	100	12,8 ~ 13,8	90,00 €	

*D'un seul côté Single end De una sola punta Ad un solo lato

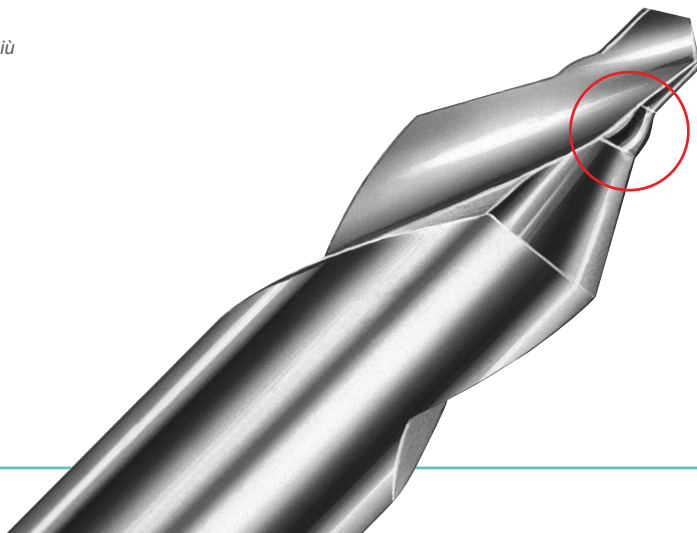



HSS

ASA N°	D x d h7 k12	L ± 1	ℓ mini maxi	magafor 145
1 - W	3,17 x 1,19 (1/8 x 3/64)	31	1,4 ~ 1,7	10,94 €
2 - W	4,76 x 1,98 (3/16 x 5/64)	47	2,4 ~ 2,7	10,94 €
3 - W	6,35 x 2,77 (1/4 x 7/64)	50	3,3 ~ 3,9	10,94 €
4 - W	7,93 x 3,17 (5/16 x 1/8)	54	3,8 ~ 4,4	12,47 €
5 - W	11,11 x 4,76 (7/16 x 3/16)	70	5,9 ~ 6,5	20,68 €
6 - W	12,70 x 5,55 (1/2 x 7/32)	76	6,9 ~ 7,5	23,11 €
7 - W	15,87 x 6,35 (5/8 x 1/4)	82	8,0 ~ 8,6	33,44 €
8 - W	19,05 x 7,93 (3/4 x 5/16)	89	10,0 ~ 10,6	60,21 €



HSS

ISO • NFE 66051-BW
DIN 333-BW • JIS-1

D x d h7 k12	L ± 1	K js13	ℓ mini maxi	magafor 023
6,3 x 1,6	45	3,3	2,0 ~ 2,6	12,04 €
8,0 x 2,0	50	4,2	2,5 ~ 3,1	13,85 €
10,0 x 2,5	55	5,3	3,1 ~ 3,8	17,38 €
11,2 x 3,15	62	6,7	3,9 ~ 4,6	25,30 €
14,0 x 4,0	69	8,5	5,0 ~ 5,9	35,87 €
18,0 x 5,0	77	10,6	6,3 ~ 7,2	49,85 €
20,0 x 6,3	80	13,2	8,0 ~ 8,9	69,31 €

Avec chanfrein et bourrelet de renfort With chamfer and reinforcing bulge

Con chaflán y refuerzo
Con smusso e bordino di rinforzo

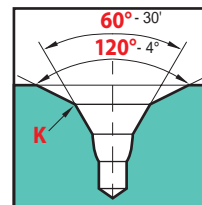

Emballage Packaging
Embalaje Imballo

magafor 023-14
10 pièces piezas pezzi D x d ≤ 10 x 4
magafor 145

10 pièces piezas pezzi N° 1W ~ 5W

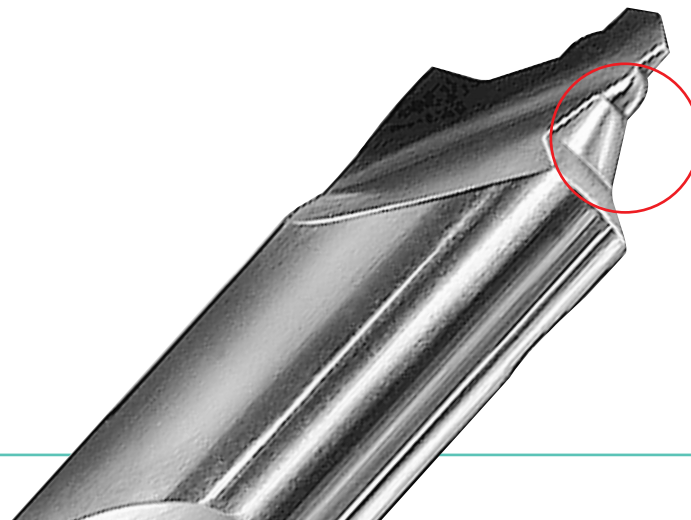

Centrage • Pointage / Centering • Spotting
Centratura • Centratore NC / Centrato • Punteado

À rayon Forme R With radius Form R

Con radio Forma R

A raggio Forma R

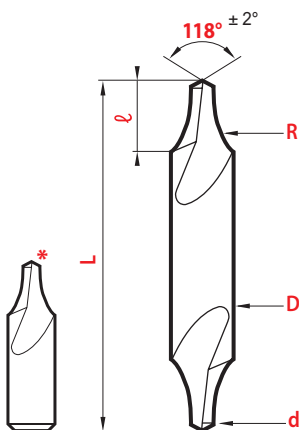
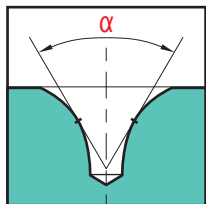

Le foret à centrer à rayon **magafor** par son profil spécial est plus performant que le foret à centrer à 60° :

- le rayon supprime l'amorce de rupture,
- il assure une portée précise de la contre-pointe,
- il fait office de chanfrein de protection.

Magafor center drill with radius, thanks to its special

profile, is more robust than the 60° center drill :

- the radius eliminates the risk of breakage,
- it provides an exact bearing,
- it serves as a protective chamfer.

La broca de centrar con radio **magafor** gracias a su perfil especial es más robusta que la broca de centrar de 60° :

- El radio suprime el riesgo de rotura,
- Asegura un posicionamiento preciso del contra-punto,
- Hace función de chaflán de protección.

La punta a centrare a raggio **magafor**, grazie alla sua sagoma speciale, è più robusta della punta a centrare a 60° :

- il profilo raggiato elimina i rischi di rottura,
- assicura una spinta costante della contro-punta,
- funge da smusso di protezione. necessità di lavorazione.

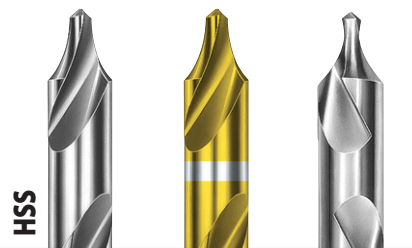

ISO • NFE 66051-R
DIN 333-R • JIS-1

Type Tipo							
D x d	L	R	ℓ		magafor 12	TIN 0812	magafor 170
h7 k12	± 1	1,25 R	mini	maxi			
3,0 x 0,5	31	2,0	2,3	~ 2,6	11,80 €		
3,15 x 0,5*	25	2,0	2,3	~ 2,6	5,71 €		
3,15 x 0,8*	25	2,5	2,6	~ 2,9	5,71 €		
3,15 x 1,0	31	2,9	3,0	~ 3,3	5,71 €	11,86 €	11,93 €
3,15 x 1,25	31	3,15	3,3	~ 3,6	5,71 €	11,86 €	11,93 €
3,5 x 0,5	35	3,0	2,7	~ 3,0	12,16 €		
3,5 x 0,75	35	3,4	2,8	~ 3,1	6,94 €		
4,0 x 1,0	35	3,9	3,3	~ 3,6	6,20 €	12,47 €	
4,0 x 1,25	35	4,0	3,7	~ 4,1	6,20 €		
4,0 x 1,6	35	4,0	4,2	~ 4,7	5,96 €	12,21 €	11,31 €
5,0 x 1,5	40	5,0	4,5	~ 4,9	6,94 €	13,68 €	
5,0 x 1,6	40	5,0	4,5	~ 4,9	6,94 €		
5,0 x 2,0	40	5,0	5,0	~ 5,4	6,46 €	13,20 €	11,55 €
6,0 x 2,0	45	5,8	5,4	~ 5,8	7,54 €	14,84 €	
6,3 x 2,0	45	6,3	5,6	~ 6,0	7,54 €		
6,3 x 2,5	45	6,3	6,3	~ 6,8	7,18 €	14,48 €	12,04 €
8,0 x 2,5	50	8,0	7,5	~ 8,0	8,28 €	16,18 €	
8,0 x 3,0	50	8,0	8,0	~ 8,5	8,28 €	16,18 €	14,89 €
8,0 x 3,15	50	8,0	8,0	~ 8,5	8,28 €	16,18 €	14,89 €
10,0 x 3,0	55	10,0	8,9	~ 9,4	10,82 €	20,62 €	
10,0 x 3,15	55	10,0	8,9	~ 9,4	10,82 €		
10,0 x 4,0	55	10,0	10,0	~ 10,6	10,58 €	20,62 €	27,36 €
12,0 x 4,0	63	11,5	10,7	~ 11,3	18,24 €	38,34 €	
12,0 x 5,0	63	11,5	11,4	~ 12,0	18,24 €		
12,5 x 4,0	63	12,5	11,2	~ 11,8	18,24 €		
12,5 x 5,0	63	12,5	12,5	~ 13,1	17,94 €	36,37 €	39,52 €
14,0 x 5,0	69	13,4	12,8	~ 13,4	24,02 €		
16,0 x 5,0	71	16,0	14,4	~ 15,0	27,06 €		
16,0 x 6,3	71	16,0	16,0	~ 16,6	26,15 €	46,84 €	65,07 €
18,0 x 6,0	77	17,8	16,6	~ 17,2	38,92 €		
20,0 x 6,3	80	20,0	17,8	~ 19,0	54,11 €		
20,0 x 8,0	80	20,0	20,0	~ 20,7	49,25 €		124,04 €
25,0 x 10,0	100	25,0	25,0	~ 25,7	85,13 €		
31,5 x 12,5	125	31,5	31,5	~ 32,3	203,10 €		

*D'un seul côté Single end De una sola punta Ad un solo lato

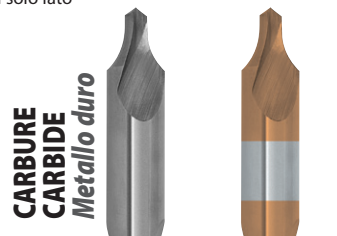

ISO • NFE 66051-R
DIN 333-R • JIS-1

D x d	L	R	ℓ		magaforce 8112	Hard'X 8112-H
h5 k12	± 1	1,25 R	mini	maxi		
3,15 x 0,5 ⁽¹⁾	25	2,0	2,3	~ 2,6	48,64 €	54,73 €
3,15 x 1,0	31	2,9	3,0	~ 3,3	51,68 €	58,98 €
3,15 x 1,25	31	3,15	3,3	~ 3,6	51,68 €	58,98 €
4,0 x 1,6	35	4,0	4,2	~ 4,7	54,73 €	62,02 €
5,0 x 2,0	40	5,0	5,0	~ 5,4	66,89 €	76,01 €
6,3 x 2,5	45	6,3	6,3	~ 6,8	79,04 €	88,17 €
8,0 x 3,15	50	8,0	8,0	~ 8,5	97,29 €	109,45 €
10,0 x 4,0	55	10,0	10,0	~ 10,6	127,69 €	142,90 €
12,5 x 5,0	63	12,5	12,5	~ 13,1	212,83 €	231,07 €

(1) D'un seul côté Single end De una sola punta Ad un solo lato

Avec plat

With flat

Con plano

Con piano

ISO • NFE 66051-R
DIN 333-R • JIS-1

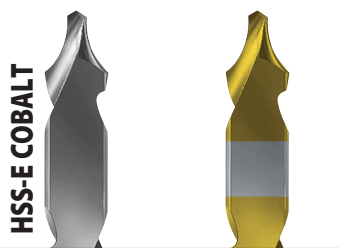
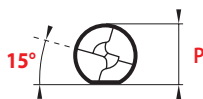

performances
➤ p. 17

D x d	L	R	ℓ	P	magafor 0291	TIN 0891
h7 k12	± 1	1,25 R	mini maxi	-0,1		
4,0 x 1,6	35	4,0	4,2 ~ 4,7	3,25	9,23 €	14,48 €
5,0 x 2,0	40	5,0	5,0 ~ 5,4	4,20	10,34 €	16,05 €
6,3 x 2,5	45	6,3	6,3 ~ 6,8	5,35	11,31 €	17,87 €
8,0 x 3,15	50	8,0	8,0 ~ 8,5	6,95	13,68 €	20,36 €
10,0 x 4,0	55	10,0	10,0 ~ 10,6	8,40	21,40 €	31,02 €
12,5 x 5,0	63	12,5	12,5 ~ 13,1	10,95	29,18 €	47,42 €
16,0 x 6,3	71	16,0	16,0 ~ 16,6	14,00	47,42 €	66,27 €
20,0 x 8,0	80	20,0	20,0 ~ 20,7	17,90	74,79 €	

Longs

Largas

Serie lunga

magafor standard



L	D x d	R	ℓ	magafor 187
± 1	h7 k12	1,25 R	mini maxi	
120	4,0 x 1,0	3,9	3,3 ~ 3,6	53,51 €
	5,0 x 1,5	5,0	4,5 ~ 4,9	52,29 €
	6,0 x 2,0	5,8	5,4 ~ 5,8	52,29 €
	8,0 x 2,5	8,0	7,5 ~ 8,0	60,80 €
	10,0 x 3,0	10,0	8,9 ~ 9,4	69,31 €
	10,0 x 4,0	10,0	10,0 ~ 10,6	69,31 €



ASA N°	D x d	L	R	ℓ	magafor 125
	h7 k12	± 1	1,25 R	mini maxi	
1 - R	3,17 x 1,19 (1/8 x 3/64)	31	3,9	3,3 ~ 3,7	6,34 €
2 - R	4,76 x 1,98 (3/16 x 5/64)	47	5,8	5,2 ~ 5,6	7,04 €
3 - R	6,35 x 2,77 (1/4 x 7/64)	50	8,0	7,0 ~ 7,5	7,85 €
4 - R	7,93 x 3,17 (5/16 x 1/8)	54	10,0	8,7 ~ 9,3	9,14 €
5 - R	11,11 x 4,76 (7/16 x 3/16)	70	12,5	12,3 ~ 12,9	17,76 €
6 - R	12,70 x 5,55 (1/2 x 7/32)	76	13,4	13,4 ~ 14,5	19,91 €
7 - R	15,87 x 6,35 (5/8 x 1/4)	82	17,8	17,0 ~ 17,7	29,97 €
8 - R	19,05 x 7,93 (3/4 x 5/16)	89	20,0	20,6 ~ 21,4	55,28 €



Emballage Packaging

Embalaje Imballo

magafor 12-125

10 pièces piezas pezzi D x d ≤ 10 x 4 / 5R



Centrage • Pointage / Centering • Spoting
Centratura • Centratore NC / Centrato • Punteado

Avec chanfrein de protection Form B With protective angle Form B

Con chaflán de protección Forma B
Con smusso di protezione Forma B

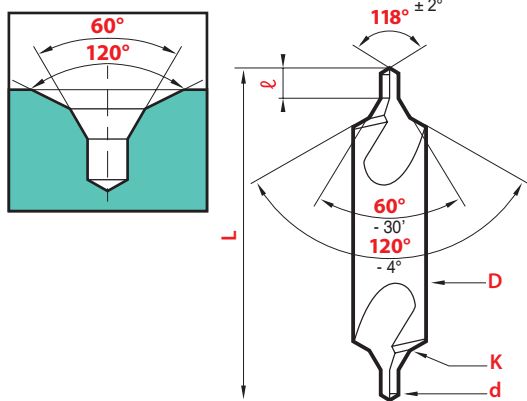

Le foret à centrer avec chanfrein de protection garantit le centre obtenu contre tout risque de choc et de déformation. L'évasement résultant du chanfrein de protection facilite la prise entre pointes des pièces sur machine à alimentation automatique.

Center drill with protective chamfer protects the center obtained from any risk of blows and deformation. The splay resulting from the protective chamfer makes it easier to load parts between centers on machine with automatic feed.

Las brocas de centrar con chaflán de protección garantizan el centrado obtenido contra todo riesgo de choque y deformación. La abertura resultante del chaflán de protección facilita la unión entre puntos de las piezas sobre máquinas de alimentación automáticas.

La punta a centrare con smusso di protezione garantisce il centro ottenuto contro ogni rischio di urti e di deformazioni. La svasatura risultante dallo smusso di protezione facilita la presa dei pezzi fra le punte su macchine con caricamento automatico.

ISO • NFE 66051-B
DIN 333-B • JIS-2

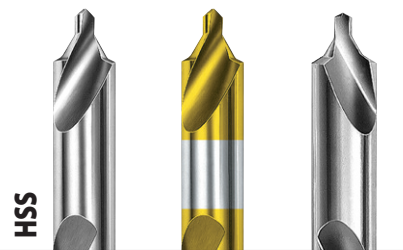

Type Tipo					HSS		
					TIN		
					magafor		
D x d	L	K	ℓ	13	0813	173	
h7 k12	± 1	js13	mini maxi				
3,0 x 0,5	31	1,2	0,6 ~ 0,9	13,85 €			
4,0 x 0,75	35	2,0	1,0 ~ 1,3	12,04 €			
4,0 x 1,0	35	2,1	1,3 ~ 1,7	9,85 €	16,12 €	20,98 €	
5,0 x 1,25	40	2,6	1,6 ~ 2,0	9,85 €	16,60 €	22,19 €	
5,0 x 1,5*	40	3,0	2,0 ~ 2,6	11,31 €			
6,0 x 1,0	45	2,5	1,3 ~ 1,7	12,77 €			
6,0 x 2,0*	45	4,0	2,5 ~ 3,1	12,77 €	20,12 €		
6,3 x 1,6	45	3,3	2,0 ~ 2,6	10,09 €	17,38 €	25,84 €	
8,0 x 1,5	50	3,8	2,0 ~ 2,6	14,60 €			
8,0 x 2,0	50	4,2	2,5 ~ 3,1	11,80 €	19,69 €	29,18 €	
8,0 x 2,5*	50	5,5	3,1 ~ 3,8	14,60 €			
8,0 x 3,0*	50	6,0	3,9 ~ 4,6	14,60 €	22,49 €		
10,0 x 2,0	55	5,0	2,5 ~ 3,1	17,63 €			
10,0 x 2,5	55	5,3	3,1 ~ 3,8	14,89 €	25,24 €	31,02 €	
10,0 x 3,0*	55	7,0	3,9 ~ 4,6	17,63 €			
10,0 x 4,0*	55	8,0	5,0 ~ 5,9	17,63 €	28,01 €		
11,2 x 3,15	62	6,7	3,9 ~ 4,6	21,28 €	38,62 €	36,49 €	
12,0 x 2,5	63	6,3	3,1 ~ 3,8	26,46 €			
12,0 x 4,0*	63	9,0	5,0 ~ 5,9	24,62 €	41,98 €		
12,0 x 5,0*	63	9,0	6,3 ~ 7,2	24,62 €			
14,0 x 3,0	69	7,5	3,9 ~ 4,6	33,44 €			
14,0 x 4,0	69	8,5	5,0 ~ 5,9	29,49 €	52,90 €	48,64 €	
14,0 x 5,0*	69	10,0	6,3 ~ 7,2	33,44 €	56,81 €		
16,0 x 4,0	71	10,0	5,0 ~ 5,9	42,56 €			
18,0 x 4,0	77	10,0	5,0 ~ 5,9	46,22 €			
18,0 x 5,0	77	10,6	6,3 ~ 7,2	42,56 €	63,85 €	61,42 €	
18,0 x 6,0*	77	12,0	8,0 ~ 8,9	46,22 €			
20,0 x 5,0	80	12,5	6,3 ~ 7,2	75,40 €			
20,0 x 6,3	80	13,2	8,0 ~ 8,9	58,37 €	84,52 €	81,48 €	
25,0 x 6,0	100	15,0	8,0 ~ 8,9	113,72 €			
25,0 x 6,3	100	16,0	8,0 ~ 8,9	113,72 €			
25,0 x 8,0	100	17,0	10,1 ~ 11,1	96,69 €			
31,5 x 10,0	125	21,2	12,8 ~ 13,8	217,69 €			

*Dimensions recommandées = pointes fortes Suggested sizes = strong points
Dimensiones recomendadas = punta reforzada Misure consigliate = punte robuste

Avec bourrelet de renfort With reinforced bulge

Con chaflán y refuerzo
Con bordino di rinforzo

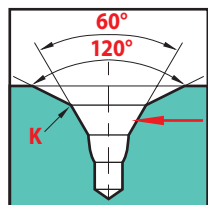

ISO • NFE 66051-BW
DIN 333-BW • JIS-2



D x d		L	K	ℓ	magafor
h7 k12	± 1	js13	mini maxi	023	
6,3 x 1,6	45	3,3	2,0 ~ 2,6	12,04 €	
8,0 x 2,0	50	4,2	2,5 ~ 3,1	13,85 €	
10,0 x 2,5	55	5,3	3,1 ~ 3,8	17,38 €	
11,2 x 3,15	62	6,7	3,9 ~ 4,6	25,30 €	
14,0 x 4,0	69	8,5	5,0 ~ 5,9	35,87 €	
18,0 x 5,0	77	10,6	6,3 ~ 7,2	49,85 €	
20,0 x 6,3	80	13,2	8,0 ~ 8,9	69,31 €	

Avec plat

With flat

Con plano
Con piano

ISO • NFE 66051-B
DIN 333-B • JIS-2

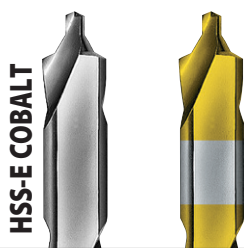
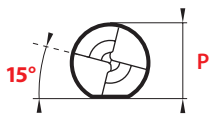

D x d	L	K	ℓ		P	magafor	TIN
h7 k12	± 1	js13	mini	maxi	-0,1	0292	0892
6,3 x 1,6	45	3,3	2,0 ~ 2,6	5,35		14,11 €	21,40 €
8,0 x 2,0	50	4,2	2,5 ~ 3,1	6,95		17,02 €	24,93 €
10,0 x 2,5	55	5,3	3,1 ~ 3,8	8,40		23,60 €	35,15 €
11,2 x 3,15	63	6,7	3,9 ~ 4,6	10,00		31,62 €	49,25 €
14,0 x 4,0	69	8,5	5,0 ~ 5,9	12,65		41,95 €	62,64 €
18,0 x 5,0	77	10,6	6,3 ~ 7,2	16,40		63,85 €	88,17 €
20,0 x 6,3	80	13,2	8,0 ~ 8,9	17,90		82,70 €	108,85 €
25,0 x 8,0	100	17,0	10,1 ~ 11,1	22,50		159,31 €	
31,5 x 10,0	125	21,2	12,8 ~ 13,8	28,40		265,12 €	

Longs

Largas
Serie lunga

magafor standard



L	D x d	K	ℓ		magafor
± 1	h7 k12	js13	mini	maxi	189
	4,0 x 1,0	2,1	1,3 ~ 1,7		81,48 €
	5,0 x 1,5	3,0	2,0 ~ 2,6		76,61 €
120	6,0 x 2,0	4,0	2,5 ~ 3,1		76,61 €
	8,0 x 2,5	5,5	3,1 ~ 3,8		90,00 €
	10,0 x 3,0	7,0	3,9 ~ 4,6		104,59 €



Emballage Packaging

Embalaje Imballo

magafor **13 - 023**

10 pièces piezas pezzi D x d ≤ 10 x 4

magafor **134 - 135**

10 pièces piezas pezzi N° 1B ~ 5B + N° 11 ~ 15



HSS

BS N°	D x d	L	K	ℓ		magafor
	h7 k12	± 1	js13	mini	maxi	134
1 - B	3,17 x 1,19 (1/8 x 3/64)	38	1,9	1,6 ~ 2,0		11,31 €
2 - B	4,76 x 1,58 (3/16 x 1/16)	45	2,8	2,0 ~ 2,4		11,31 €
3 - B	6,35 x 2,38 (1/4 x 3/32)	50	3,8	3,3 ~ 3,9		11,31 €
4 - B	7,93 x 2,77 (5/16 x 7/64)	56	4,8	4,1 ~ 4,7		12,77 €
5 - B	11,11 x 3,96 (7/16 x 5/32)	64	6,6	5,7 ~ 6,3		21,59 €
6 - B	15,87 x 5,55 (5/8 x 7/32)	76	9,5	7,7 ~ 8,3		35,27 €
7 - B	19,05 x 6,35 (3/4 x 1/4)	88	11,4	9,2 ~ 10,0		62,02 €



HSS

ASA N°	D x d	L	K	ℓ		magafor
	h7 k12	± 1	js13	mini	maxi	135
11	3,17 x 1,19 (1/8 x 3/64)	31	2,5	1,4 ~ 1,7		11,31 €
12	4,76 x 1,58 (3/16 x 1/16)	47	3,8	1,9 ~ 2,2		11,31 €
13	6,35 x 2,38 (1/4 x 3/32)	50	5,1	2,8 ~ 3,4		11,31 €
14	7,93 x 2,77 (5/16 x 7/64)	54	6,3	3,3 ~ 3,9		12,77 €
15	11,11 x 3,96 (7/16 x 5/32)	70	8,9	4,8 ~ 5,4		21,59 €
16	12,70 x 4,76 (1/2 x 3/16)	76	10,1	5,9 ~ 6,5		24,02 €
17	15,87 x 5,55 (5/8 x 7/32)	82	12,7	6,9 ~ 7,5		35,27 €
18	19,05 x 6,35 (3/4 x 1/4)	89	15,2	8,0 ~ 8,6		62,02 €
19	22,22 x 7,93 (7/8 x 5/16)	92	17,8	10,0 ~ 10,6		74,79 €
20	25,40 x 9,52 (1 x 3/8)	95	20,3	12,1 ~ 12,7		106,41 €



Forets à centrer • Center drills

Brocas de centrar • Punte a centrare

90°

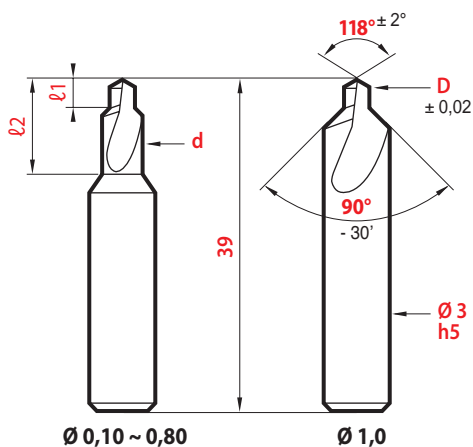
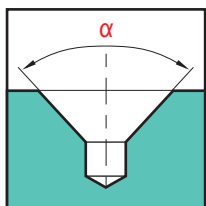

Ø 0,10 ~ 0,80

Ø 1,0

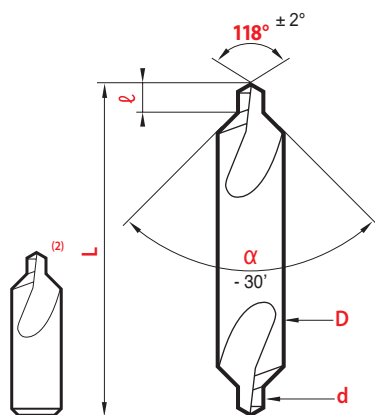

CARBURE CARBIDE
Metallo duro



D	d	l1	l2	magaforce 82X-1
0,10	0,55	0,10	1,8	39,52 €
0,15	0,55	0,15	1,8	38,92 €
0,20	0,55	0,20	1,8	38,31 €
0,25	0,85	0,25	2,7	37,69 €
0,30	0,85	0,30	2,7	36,49 €
0,40	1,4	0,40	4,5	35,27 €
0,50	1,4	0,50	4,5	35,27 €
0,60	2,3	0,60	7,2	35,27 €
0,80	2,3	0,80	7,2	35,27 €
1,00	-	1,00	-	35,27 €



Type
Tipo

D x d	L	l	magafor 15	magafor 175	magaforce 8115	Hard'X 8115-H
3,0 x 0,5 ⁽²⁾	25	0,6 ~ 0,9	15,50 €			
3,5 x 0,75	35	1,0 ~ 1,3	13,99 €			
4,0 x 1,0	35	1,3 ~ 1,7	12,77 €	40,75 €	69,00 €	76,01 €
5,0 x 1,5	40	2,0 ~ 2,6	13,06 €	43,78 €		
6,0 x 2,0	45	2,5 ~ 3,1	16,12 €	46,22 €	96,00 €	106,41 €
8,0 x 2,5	50	3,1 ~ 3,8	18,55 €	49,25 €		
8,0 x 3,0	50	3,9 ~ 4,6	18,55 €	49,25 €	118,00 €	130,74 €
10,0 x 3,0	55	3,9 ~ 4,6	24,02 €	56,55 €		
10,0 x 4,0	55	5,0 ~ 5,9	24,02 €	56,55 €	156,00 €	170,27 €
12,0 x 4,0	63	5,0 ~ 5,9	36,49 €			
12,0 x 5,0	63	6,3 ~ 7,2	36,49 €			
14,0 x 5,0	69	6,3 ~ 7,2	50,47 €			
18,0 x 6,0	77	8,0 ~ 8,9	74,18 €			
25,0 x 8,0	100	10,1 ~ 11,1	159,31 €			

(1) CARBURE CARBIDE METAL DURO METALLO DURO = h5
(2) D'un seul côté Single end De una sola punta Ad un solo lato

Longs

Largas
Serie lunga

HSS-E COBALT



D x d	L	l	magafor 188
h7 k12	± 1	mini maxi	
4,0 x 1,0	120	1,3 ~ 1,7	81,48 €
5,0 x 1,5	120	2,0 ~ 2,6	76,61 €
6,0 x 2,0	120	2,5 ~ 3,1	76,61 €
8,0 x 2,5	120	3,1 ~ 3,8	84,08 €
10,0 x 3,0	120	3,9 ~ 4,6	92,95 €
10,0 x 4,0	120	5,0 ~ 5,9	92,95 €

Special

2 semaines • 2 weeks

2 semanas • 2 settimane

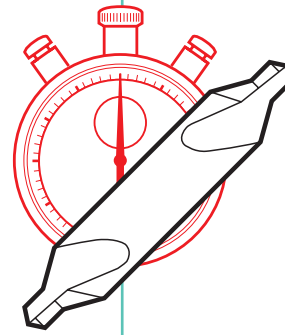

Nous disposons d'ébauches qui permettent de réaliser nombre d'outils spéciaux: consultez-nous en complétant le croquis correspondant à votre centrage.

Our stock of semi-finished tools enables us to manufacture many specials: with your inquiries please complete the appropriate sketch with your centering operation.

Nuestro stock de herramientas semi-elaboradas nos permite la fabricación de numerosas herramientas especiales con sus peticiones rellene el croquis adecuado a sus necesidades.

Disponiamo di sbozzati che ci consentono di costruire numerosi utensili speciali: consultateci completando il disegno corrispondente alla vostra necessità.

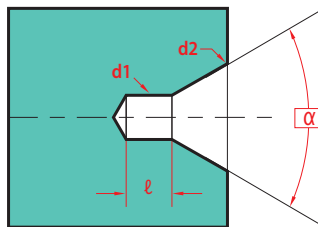

d1 = l =
d2 = alpha =

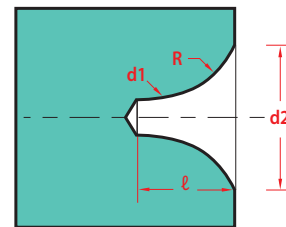

d1 = R =
d2 = l =

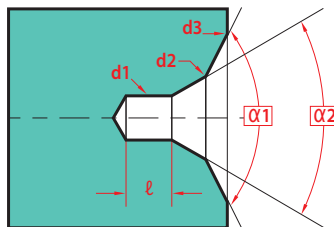

d1 = l =
d2 = alpha1 =
d3 = alpha2 =

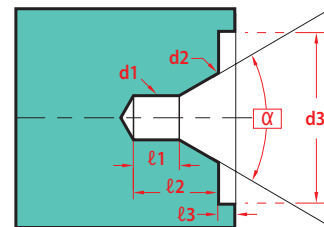

d1 = l1 =
d2 = l2 =
d3 = l3 =
alpha =

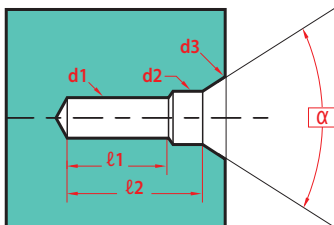

d1 = l1 =
d2 = l2 =
d3 = alpha =

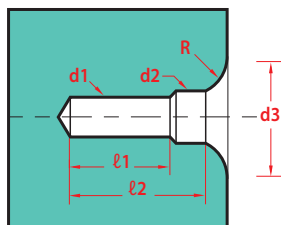

d1 = R =
d2 = l1 =
d3 = l2 =

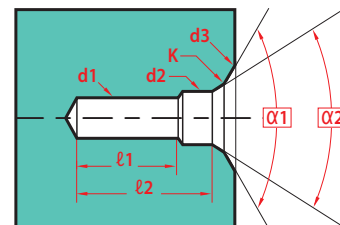

d1 = K =
d2 = l1 =
d3 = l2 =
alpha1 = alpha2 =

Matière à usiner / Material to machine
Material a mecanizar / Materiale da lavorare

Quantité d'outils / Number of tools
Número de herramientas / Numero pezzi

Tolérance spéciale / Special tolerance
Tolerancia especial / Tolleranza speciale

Nom et adresse
Nombre y dirección

Name and address
Nome ed indirizzo



Forets à centrer • Center drills

Brocas de centrar • Punte a centrare

Les bouts d'arbres filetés

For threaded holes

Para los extremos de ejes roscados

Per le estremità di alberi filettati



Principale utilisation :
pour centrer et percer les axes de moteurs électriques, pompes et moto-réducteurs.

Ces forets à centrer sont conçus pour réaliser en une seule opération :

- 1 - l'avant-trou de taraudage,
- 2 - l'entrée de taraud,
- 3 - le centre.

Les codes **0280 - 0288 - 0284** ont un plat de serrage et pour le logement d'un outil de dressage. Les deux rainures latérales facilitent la lubrification.

Main use :

to center and to bore the shafts of electric motors, pumps and speed-reducing gear.

These Center drills are designed to do the following in a single operation :

- 1 - make the preliminary tap hole,
- 2 - make the tap entrance,
- 3 - do the centering.

The code **0280 - 0288 - 0284** have a flat for a blocking screw and carbide insert. The two side grooves facilitate lubrication.

Usa principal :

Centrado y taladrado de ejes de motores eléctricos, bombas, motoreductores.

Estas brocas de centrar están

diseñadas para realizar en una sola operación :

- 1 - el agujero previo de roscado,
- 2 - la entrada de rosca,
- 3 - el centrado.

El código 0280 - 0288 - 0284 incorporan un plano de bloqueo para el tornillo de apriete y la placa de metal duro. Las dos ranuras laterales facilitan la lubricación.

Principale impiego :

per centrare e forare gli assi di motori elettrici, pompe e moto-riduttori.

Queste punte a centrare sono concepite per realizzare in un'unica operazione :

- 1 - l'avanforo di filettatura,
- 2 - l'imboccatura per il maschio,
- 3 - la centratura.

Gli articoli 0280 - 0288 - 0284 presentano un piano di bloccaggio anche per il posizionamento all'interno di una macchina intestatrice. Le due scanalature laterali favoriscono la lubrificazione.

Forme D

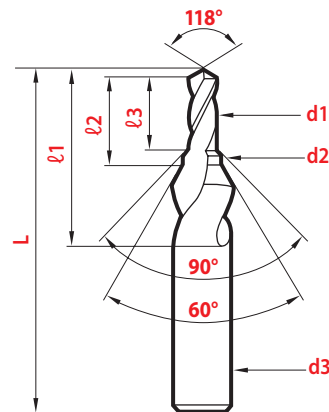
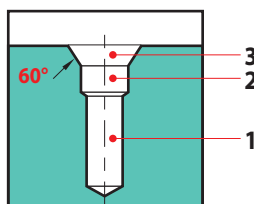

Forme DR

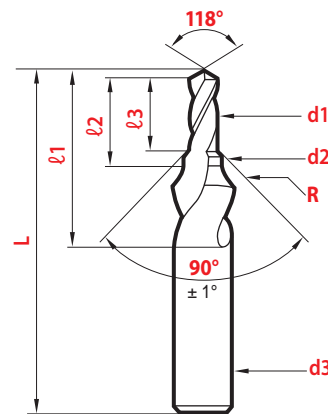
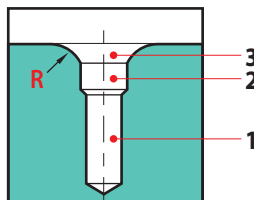

Forme DS

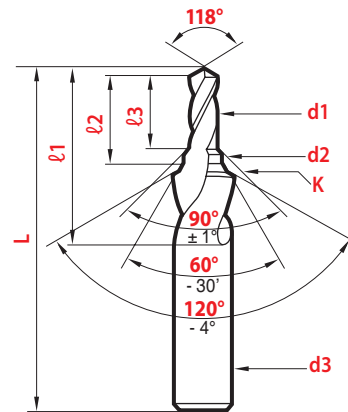
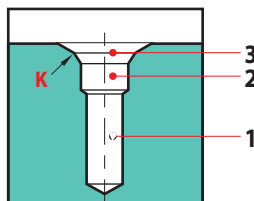

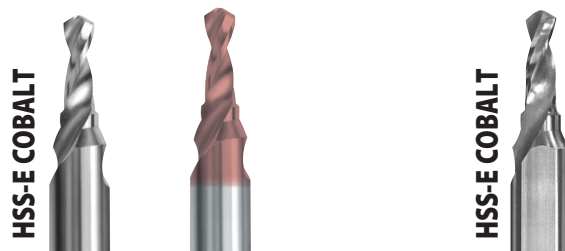

DIN 332/2 - **Forme D**

Sans plat
Without flat
Sin plano
Senza piano



Avec plat
With flat
Con plano
Con piano

VIS VITE Kernloch	d1 -0/-0,05	d2 ± 0,5	d3 h7	L ± 1	ℓ1	ℓ2	ℓ3	magafor 0285	Red'X 0985	P -0,1	magafor 0280
M3	2,5	3,2	6,0	55	18	9,0	8	54,73 €	61,70 €		
M4	3,3	4,3	8,0	63	23	12,6	11	48,64 €	59,12 €	6,75	66,89 €
M5	4,2	5,3	10,0	67	27	15,1	13	57,77 €	70,57 €	8,45	72,97 €
M6	5,0	6,4	12,5	71	33	18,9	16	66,89 €	83,10 €	10,45	91,21 €
M8	6,8	8,4	14,0	88	41	23,0	19	72,97 €	91,06 €	12,50	97,29 €
M10	8,5	10,5	16,0	90	47	27,7	23	85,13 €	109,77 €	14,85	109,45 €
M12	10,2	13,0	20,0	105	59	34,5	28	103,37 €	139,04 €	18,45	133,78 €
M16	14,0	17,0	25,0	132	67	41,3	33			23,45	255,39 €
M20	17,5	21,0	31,5	145	77	48,3	38			29,35	352,68 €
M24	21,0	25,0	40,0	160	90	57,0	45			36,50	547,27 €

DIN 332/2 - **FORME DR**

Sans plat
Without flat
Sin plano
Senza piano



Avec plat
With flat
Con plano
Con piano

VIS VITE Kernloch	d1 -0/-0,05	d2 ± 0,5	d3 h7	L ± 1	ℓ1	ℓ2	ℓ3	R*	magafor 0287	P -0,1	magafor 0288
M4	3,3	4,3	8,0	63	23	12,6	11	4	57,77 €	6,75	79,04 €
M5	4,2	5,3	10,0	67	27	15,1	13	6	66,89 €	8,45	85,13 €
M6	5,0	6,4	12,5	71	33	18,9	16	8	79,04 €	10,45	103,37 €
M8	6,8	8,4	14,0	88	41	23,0	19	10	88,17 €	12,50	112,50 €
M10	8,5	10,5	16,0	90	47	27,7	23	16	100,33 €	14,85	124,66 €
M12	10,2	13,0	20,0	105	59	34,5	28	20	121,62 €	18,45	155,06 €
M16	14,0	17,0	25,0	132	70	41,3	33	25		23,40	291,87 €
M20	17,5	21,0	31,5	145	77	48,3	38	31,5		29,35	425,65 €
M24	21,0	25,0	40,0	160	98	57	45	40		36,50	626,31 €

*R maxi = 1,25 R

DIN 332/2 - **FORME DS**

Sans plat
Without flat
Sin plano
Senza piano



Avec plat
With flat
Con plano
Con piano

VIS VITE Kernloch	d1 -0/-0,05	d2 ± 0,5	d3 h7	L ± 1	ℓ1	ℓ2	ℓ3	K js13	magafor 0283	P -0,1	magafor 0284
M4	3,3	4,3	8	63	23	12,6	11	6,4	57,77 €	6,75	79,04 €
M5	4,2	5,3	10	67	27	15,1	13	7,8	66,89 €	8,45	85,13 €
M6	5,0	6,4	12,5	71	33	18,9	16	9,1	79,04 €	10,45	103,37 €
M8	6,8	8,4	14,0	88	41	23,0	19	11,8	88,17 €	12,50	112,50 €
M10	8,5	10,5	18,0	90	47	27,7	23	14,2	100,33 €	14,85	124,66 €
M12	10,2	13,0	20,0	105	59	34,5	28	17,4	121,62 €	18,45	155,06 €
M16	14,0	17,0	26,0	132	70	41,3	33	21,9		23,40	291,87 €

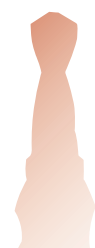

Revêtements : nous consulter.

Coating : please inquire

Recubrimiento : sobre pedido

Rivestimento : consultateci

Forets à pointer NC • NC spotting drill

Brocas de puntear • Punte a centrare

Double

Doble punta
Doppie

DUO-mag

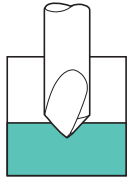

Centrage - Pointage
Centering - Spotting
Centrado - Punteado
Centratura

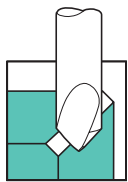

Chanfrein longitudinal
Longitudinal chamfer
Chaflanes longitudinales
Smussi longitudinali

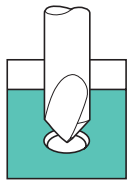

Chanfreinage
Chamfering
Chaflanado
Sbavatura

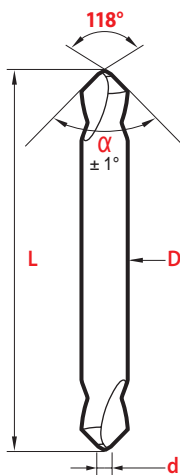

L'angle d'affûtage 118° favorise la pénétration, tout en renforçant la pointe.

The 118° sharpening angle improves tool penetration, while reinforcing the point.

El ángulo de 118° favorece la penetración, reforzando la punta.

L'angolo di affilatura a 118° agevola la penetrazione, rinforzando al tempo stesso la punta.

Micro-NC
➤ p. 36



1 DUO-mag =
2 forets NC simples
2 single NC drills

2 brocas NC
2 punte NC semplici

60° DUO-mag

CARBURE
CARBIDE
Metallo duro

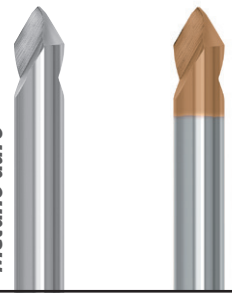

D x d h6 ± 0,05	L ± 1	DUO-mag 8116	Hard'X 8116-H
3,0 x 0,5	40	57,77 €	65,07 €
4,0 x 1,0	45	63,85 €	71,75 €
6,0 x 2,0	55	72,37 €	81,48 €
8,0 x 2,5	65	95,46 €	106,41 €
10,0 x 3,0	75	130,13 €	144,12 €
12,0 x 3,5	85	199,45 €	216,47 €

90° DUO-mag

CARBURE
CARBIDE
Metallo duro

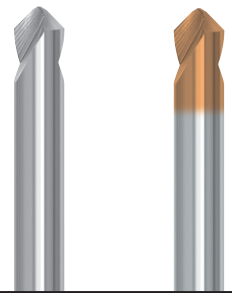

D x d h6 ± 0,05	L ± 1	DUO-mag 8119	Hard'X 8119-H
3,0 x 0,5	40	57,77 €	65,07 €
4,0 x 1,0	45	63,85 €	71,75 €
6,0 x 2,0	55	72,37 €	81,48 €
8,0 x 2,5	65	95,46 €	106,41 €
10,0 x 3,0	75	130,13 €	144,12 €
12,0 x 3,5	85	199,45 €	216,47 €

Promo-kits



90°

Type Tipo	DUO-mag 019	DUO-mag 0919
6 pièces 6 pieces 6 pieza 6 pezzi	Ø 3 - 4 - 6 - 8 - 10 - 12	
	105,81 €	158,10 €

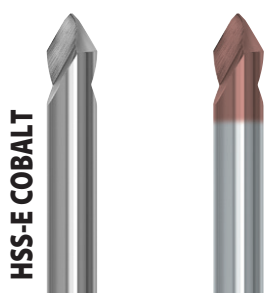

HSS-E COBALT

60° DUO-mag

D x d	L	DUO-mag 016	Red'X 0916
h7 ± 0,05	± 1		
3,0 x 0,5	40	13,06 €	18,55 €
4,0 x 1,0	45	13,37 €	19,77 €
6,0 x 2,0	55	14,89 €	23,42 €
8,0 x 2,5	65	18,55 €	27,67 €
10,0 x 3,0	75	20,98 €	32,23 €
12,0 x 3,5	85	28,87 €	43,17 €
16,0 x 4,0	90	41,95 €	63,24 €
20,0 x 5,0	100	80,88 €	113,72 €

DUO-mag

N°	D x d	L	DUO-mag 016	Red'X 0916
	h7 ± 0,05	± 1		
1	4,76 x 1,59 (3/16 x 1/16)	50,8 (2")	13,37 €	19,77 €
2	6,35 x 2,38 (1/4 x 3/32)	50,8 (2")	14,89 €	23,42 €
3	9,52 x 3,57 (3/8 x 9/64)	76,2 (3")	20,98 €	32,23 €
4	12,7 x 4,76 (1/2 x 3/16)	101,6 (4")	28,87 €	43,17 €

DUO-mag Longs *Largas Serie lunga*

D x d	L	DUO-mag 016-L	Red'X 0916-L
h7 ± 0,05	± 1		
3,0 x 0,5	100	19,46 €	28,28 €
4,0 x 1,0	100	20,36 €	29,80 €
6,0 x 2,0	100	22,49 €	35,27 €
8,0 x 2,5	100	27,67 €	41,34 €
10,0 x 3,0	100	31,62 €	47,42 €
12,0 x 3,5	100	43,17 €	65,07 €

DUO-mag

N°	D x d	L	DUO-mag 016-L	Red'X 0916-L
	h7 ± 0,05	± 1		
1	4,76 x 1,59 (3/16 x 1/16)	101,6 (4")	20,36 €	29,80 €
2	6,35 x 2,38 (1/4 x 3/32)	101,6 (4")	22,49 €	35,27 €
3	9,52 x 3,57 (3/8 x 9/64)	127 (5")	31,62 €	47,42 €
4	12,7 x 4,76 (1/2 x 3/16)	152,4 (6")	43,17 €	65,07 €

DUO-mag X-Longs *X-Largas Serie Extra-lunga*

D x d	L	DUO-mag 016-XL	Red'X 0916-XL
h7 ± 0,05	± 1		
8,0 x 2,5	150	37,09 €	55,33 €
10,0 x 3,0	150	41,95 €	63,85 €
12,0 x 3,5	150	57,77 €	86,35 €
16,0 x 4,0	150	62,64 €	95,46 €
20,0 x 5,0	150	121,62 €	169,04 €

90° DUO-mag

D x d	L	DUO-mag 019	Red'X 0919
h7 ± 0,05	± 1		
3,0 x 0,5	40	13,06 €	18,55 €
4,0 x 1,0	45	13,37 €	19,77 €
6,0 x 2,0	55	14,89 €	23,42 €
8,0 x 2,5	65	18,55 €	27,67 €
10,0 x 3,0	75	20,98 €	32,23 €
12,0 x 3,5	85	28,87 €	43,17 €
16,0 x 4,0	90	41,95 €	63,24 €
20,0 x 5,0	100	80,88 €	113,72 €

DUO-mag

N°	D x d	L	DUO-mag 019	Red'X 0919
	h7 ± 0,05	± 1		
1	4,76 x 1,59 (3/16 x 1/16)	50,8 (2")	13,37 €	19,77 €
2	6,35 x 2,38 (1/4 x 3/32)	50,8 (2")	14,89 €	23,42 €
3	9,52 x 3,57 (3/8 x 9/64)	76,2 (3")	20,98 €	32,23 €
4	12,7 x 4,76 (1/2 x 3/16)	101,6 (4")	28,87 €	43,17 €

DUO-mag Longs *Largas Serie lunga*

D x d	L	DUO-mag 019-L	Red'X 0919-L
h7 ± 0,05	± 1		
3,0 x 0,5	100	19,46 €	28,28 €
4,0 x 1,0	100	20,36 €	29,80 €
6,0 x 2,0	100	22,49 €	35,27 €
8,0 x 2,5	100	27,67 €	41,34 €
10,0 x 3,0	100	31,62 €	47,42 €
12,0 x 3,5	100	43,17 €	65,07 €

DUO-mag

N°	D x d	L	DUO-mag 019-L	Red'X 0919-L
	h7 ± 0,05	± 1		
1	4,76 x 1,59 (3/16 x 1/16)	50,8 (2")	20,36 €	29,80 €
2	6,35 x 2,38 (1/4 x 3/32)	50,8 (2")	22,49 €	35,27 €
3	9,52 x 3,57 (3/8 x 9/64)	76,2 (3")	31,62 €	47,42 €
4	12,7 x 4,76 (1/2 x 3/16)	101,6 (4")	43,17 €	65,07 €

DUO-mag X-Longs *X-Largas Serie Extra-lunga*

D x d	L	DUO-mag 019-XL	Red'X 0919-XL
h7 ± 0,05	± 1		
8,0 x 2,5	150	37,09 €	55,33 €
10,0 x 3,0	150	41,95 €	63,85 €
12,0 x 3,5	150	57,77 €	86,35 €
16,0 x 4,0	150	62,64 €	95,46 €
20,0 x 5,0	150	121,62 €	169,04 €



Courts Short

Cortas
Corte

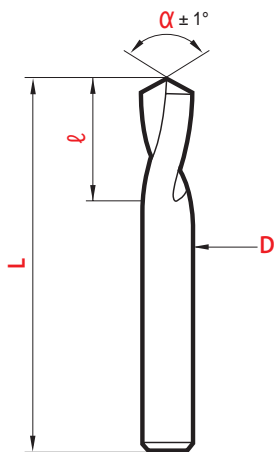
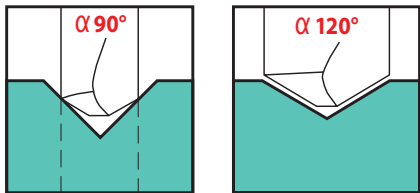

Micro-NC

CARBURE CARBIDE
Metallo duro

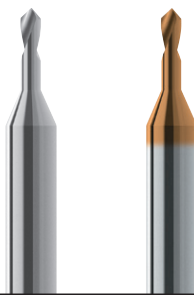

magafor standard

90°

D +0,01	ℓ	magaforce 819-D	Hard'X 819-DH
0,3*	0,9	49,85 €	55,95 €
0,4	1,2	45,61 €	51,68 €
0,5	1,5	41,65 €	46,51 €
0,6	1,8	38,92 €	43,78 €
0,7	2,1	38,92 €	43,78 €
0,8	2,4	38,92 €	43,78 €
0,9	2,7	38,92 €	43,78 €
1,0	3,0	38,92 €	43,78 €
1,2	3,6	38,92 €	43,78 €
1,5	4,5	38,92 €	43,78 €
2,0	6,0	38,92 €	43,78 €
2,5	7,5	38,92 €	43,78 €

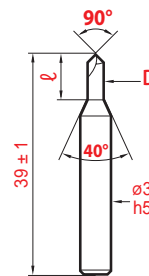

Tolérances

ℓ	
Ø 0,3 ~ 0,5	0,15
Ø 0,6 ~ 0,8	0,2
Ø 0,9 ~ 2,5	0,3

* Pointage à partir de 0,05 Spotting from 0,05 Centrado desde 0,05 Centratura da 0,05

CARBURE CARBIDE
Metallo duro



CARBURE CARBIDE
Metallo duro



magafor standard

90°

120°

90°

120°

D h5	L ± 1	ℓ +2	magaforce 8195	magaforce 8196	Hard'X 8195-H	Hard'X 8196-H
2,0	40	8	27,36 €	27,36 €	31,02 €	31,02 €
3,0	45	10	24,33 €	24,33 €	27,96 €	27,96 €
3,17 (1/8")	45	10	24,33 €		27,96 €	
4,0	50	12	29,18 €	29,18 €	32,83 €	32,83 €
4,76 (3/16")	50	15	34,06 €		37,69 €	
5,0	50	15	34,06 €	34,06 €	37,69 €	37,69 €
6,0	50	18	38,92 €	38,92 €	42,56 €	42,56 €
6,35 (1/4")	50	18	42,56 €	42,56 €	46,22 €	46,22 €
7,93 (5/16")	60	23	54,73 €		59,58 €	
8,0	60	23	54,73 €	54,73 €	59,58 €	59,58 €
9,52 (3/8")	70	24	80,26 €	80,26 €	85,13 €	85,13 €
10,0	70	24	81,48 €	81,48 €	86,35 €	86,35 €
12,0	70	24	114,32 €	114,32 €	121,62 €	121,62 €
12,70 (1/2")	70	24	124,04 €	124,04 €	132,55 €	132,55 €
14,0	75	24	169,04 €	169,04 €	179,99 €	179,99 €
15,87 (5/8")	80	26	192,15 €	192,15 €	201,89 €	201,89 €
16,0	80	26	193,38 €	193,38 €	203,10 €	203,10 €
20,0	100	35	350,26 €	350,26 €	363,62 €	363,62 €

Angle 90°: on obtiendra centrage et chanfreinage en une seule opération.

Angles 120°: L'avant-trou obtenu correspond à l'angle en bout de l'outil de perçage et évite à celui-ci de dévier.

90 degree angle: centering and chamfering are obtained in a single operation.

120 degree angle: The preliminary hole corresponds to the angle at the end of the tool used in drilling and prevents it from deviating.

Ángulo 90°: obtendrá un centrado y avellanado en una sola operación.

Ángulo de 120°: El agujero previo obtenido corresponde al ángulo de la punta de la herramienta utilizada para taladrar y previene su desvío.

Angolo 90°: si otterrà la centratura e lo smusso in un'unica operazione.

Angolo 120°: l'avanzato realizzato corrisponde all'angolo di affilatura dell'utensile a forare impedendo a quest'ultimo di deviare.

Autres types Other types

Otros tipos
Altri tipi

avec plat • with flats
con piano

➤ p. 38

extra courts • extra shorts
extra corta

➤ p. 40

HSS 8% Co
α 142°

➤ p. 38

cône morse • morse taper shank
mango cono Morse

➤ p. 41

coupe à gauche • left hand cut
corte a izquierdas • elica sinistra

➤ p. 40

longs
largas lunghe

➤ p. 42

performances
 > p. 17

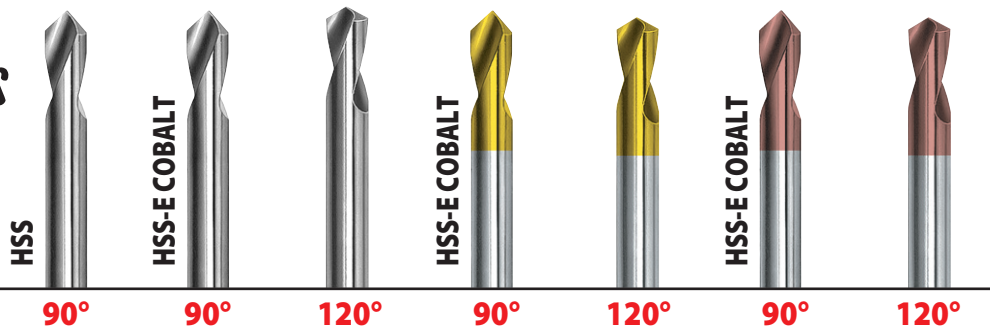

NFE 66052 • ISO 10898

D h6*	L ± 1	ℓ +1	classic 190*	magafor 195	magafor 196	TIN 0895	TIN 0896	Red'X 0995	Red'X 0996
2,0	49	8		15,20 €	15,20 €	20,06 €	20,06 €	21,28 €	21,28 €
3,0	50	10	9,61 €	12,65 €	12,65 €	17,02 €	17,02 €	18,24 €	18,24 €
3,17 (1/8")	50	10		12,89 €	12,89 €	17,28 €	17,28 €	18,48 €	18,48 €
4,0	52	12	9,97 €	13,14 €	13,14 €	18,00 €	18,00 €	19,21 €	19,21 €
4,76 (3/16")	60	15		14,11 €	14,11 €	18,97 €	18,97 €	20,19 €	20,19 €
5,0	60	15	10,71 €	14,23 €	14,23 €	19,10 €	19,10 €	20,44 €	20,44 €
6,0	66	20	11,31 €	14,60 €	14,60 €	21,16 €	21,16 €	22,49 €	22,49 €
6,35 (1/4")	66	22		16,72 €	16,72 €	23,34 €	23,34 €	24,68 €	24,68 €
7,93 (5/16")	79	25		17,94 €		25,24 €		26,75 €	
8,0	79	25	13,68 €	17,94 €	17,94 €	25,24 €	25,24 €	26,75 €	26,75 €
9,52 (3/8")	89	25		20,06 €	20,06 €	28,69 €	28,69 €	30,64 €	30,64 €
10,0	89	25	14,89 €	20,31 €	20,31 €	29,08 €	29,08 €	31,02 €	31,02 €
12,0	102	30	21,28 €	27,96 €	27,96 €	40,13 €	40,13 €	42,56 €	42,56 €
12,70 (1/2")	102	35		29,80 €	29,80 €	41,95 €	41,95 €	43,78 €	43,78 €
14,0	115	35		39,82 €	39,82 €	55,33 €	55,33 €	58,37 €	58,37 €
15,87 (5/8")	115	35		40,13 €	40,13 €	57,77 €	57,77 €	60,80 €	60,80 €
16,0	115	35	31,62 €	40,75 €	40,75 €	58,08 €	58,08 €	62,02 €	62,02 €
18,0	130	40		75,40 €	75,40 €	98,51 €	98,51 €	104,59 €	104,59 €
19,05 (3/4")	131	40		77,83 €	77,83 €	102,16 €	102,16 €	109,45 €	109,45 €
20,0	131	40	60,21 €	78,44 €	78,44 €	102,16 €	102,16 €	109,45 €	109,45 €
25,0	138	45		109,45 €	109,45 €	139,85 €	139,85 €	149,58 €	149,58 €
25,4 (1")	138	45		119,19 €	119,19 €	149,58 €	149,58 €	159,31 €	159,31 €

* Code 190 = h7

Video on line



magafor *Le choix! The choice! La elección! La scelta!*

www.magafor.com

Matière Material Materiale	HSS	HSS-E COBALT	HSS-E COBALT + TIN	HSS-E COBALT + Red'X	CARBURE CARBIDE Metallo duro	CARBURE CARBIDE + Hard'X
Dureté Hardness Durezza	63 HRC	65 HRC	65 HRC + 2300 HV	65 HRC + 3500 HV	1800 HV	1800 HV + 3500 HV
Utilisation Use Utilización Impiego	Petites séries Small series Pequeñas series Piccole serie	Production intensive Intensive production Producción intensiva Produzione intensiva		Alliages durs et abrasifs Hard and abrasive alloys Aleaciones duras y abrasivos Leghe dure e abrasive	Aciers trempés Treated steels Aceros tratados Acciai temprati	
Page Pagina	> 37-40-43	> 37 ~ 43	> 37-41-43	> 36-39-42		

Promo-kits



magafor

Type Tipo	classic 190	magafor 195 196	Tin 0895 0896	Red'X 0995 0996	magaforce 8195 8196	Hard'X 8195-H 8196-H
1 pièce 1 piece 1 pieza 1 pezzo						
		Ø 4 - 5 - 6 - 8 - 10 - 12				
	83,00 €	106,33 €	152,03 €	160,53 €	352,68 €	380,65 €

magafor

Centrage • Pointage / Centering • Spotting
 Centraturo • Centraturo NC / Centrato • Punteado



Forets à pointer NC • NC spotting drill

Brocas de puntear • Punte a centrare

Courts Short

Cortas

Corte

NFE 66052 • ISO 10898

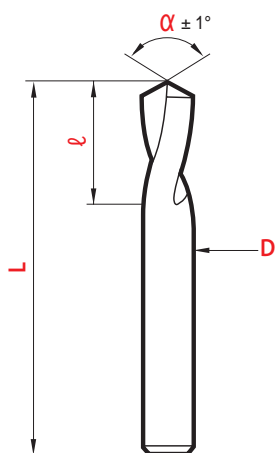
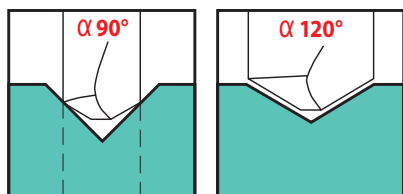

HSS 8% Co

D h6	L ±1	l +1	HSS 8% COBALT		HSS 8% COBALT		HSS 8% COBALT	
			90°	120°	90°	120°	90°	120°
			magafor 19-J	magafor 19-K	TIN 089-J	TIN 089-K	Red'X 099-J	Red'X 099-K
3,0	50	10	15,20 €	15,20 €	20,06 €	20,06 €	21,28 €	21,28 €
4,0	52	12	15,80 €	15,80 €	20,68 €	20,68 €	21,90 €	21,90 €
5,0	60	15	17,02 €	17,02 €	22,49 €	22,49 €	23,71 €	23,71 €
6,0	66	20	18,24 €	18,24 €	24,93 €	24,93 €	26,15 €	26,15 €
8,0	79	25	21,59 €	21,59 €	29,18 €	29,18 €	30,71 €	30,71 €
10,0	89	25	24,33 €	24,33 €	32,23 €	32,23 €	34,06 €	34,06 €
12,0	102	30	33,75 €	33,75 €	46,22 €	46,22 €	48,64 €	48,64 €
16,0	115	35	49,85 €	49,85 €	68,11 €	68,11 €	72,06 €	72,06 €
20,0	131	40	95,17 €	95,17 €	120,39 €	120,39 €	127,69 €	127,69 €

DIN 6535 HB Avec méplat de serrage With flat

Con plano

Attacco Weldon

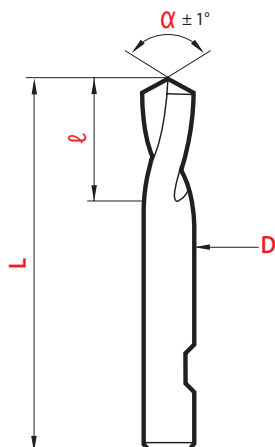

HSS-E COBALT

D h6	L ±1	l +1	HSS-E COBALT		HSS-E COBALT		HSS-E COBALT	
			90°	120°	90°	120°	90°	120°
			magafor 195-W	magafor 196-W	TIN 0895-W	TIN 0896-W	Red'X 0995-W	Red'X 0996-W
6,0	66	20	17,51 €	17,51 €	25,42 €	25,42 €	27,00 €	27,00 €
8,0	79	25	21,53 €	21,53 €	30,28 €	30,28 €	32,11 €	32,11 €
10,0	89	25	24,33 €	24,33 €	34,91 €	34,91 €	37,23 €	37,23 €
12,0	102	30	33,57 €	33,57 €	48,16 €	48,16 €	51,08 €	51,08 €
16,0	115	35	48,90 €	48,90 €	69,70 €	69,70 €	74,42 €	74,42 €
20,0	131	40	93,63 €	93,63 €	122,59 €	122,59 €	131,34 €	131,34 €

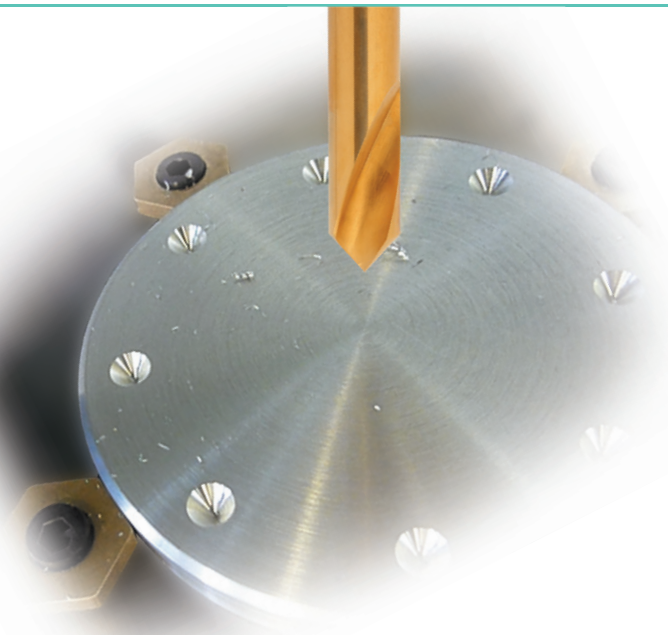

142°

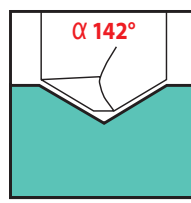

New 2024

Pour les alliages durs, l'angle à 142° prépositionne les trous, avant utilisation de forets à 135° ou 140°. Deux qualités proposées : HSS-E Cobalt et carbure monobloc. Pour les alliages fortement abrasifs la gamme **8190-H** est préconisée.

En aleaciones de alta dureza el ángulo de 142° debe usarse para la operación de punteado antes de usar brocas con 135° ó 140°. Disponibles en dos calidades: HSS-E Cobalto y Metal Duro. Para aleaciones abrasivas recomendamos la referencia **8190-H**.

In hard alloys the 142° angle has to be used for the spotting operation before the 135° or 140° twist drills. Two qualities are offered: HSS-E Cobalt and solid carbide. For abrasive alloys the **8190-H** range is recommended.

Per lavorazioni su leghe dure l'angolo a 142° consente il corretto posizionamento della punta preposta alla foratura avente angolo di 135° o 140°. Due sono le tipologie offerte: HSS-E e metallo duro. La gamma **8190-H** è raccomandata nelle lavorazioni di leghe fortemente abrasive.

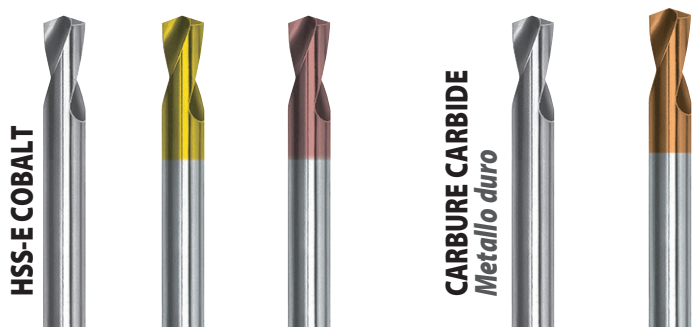
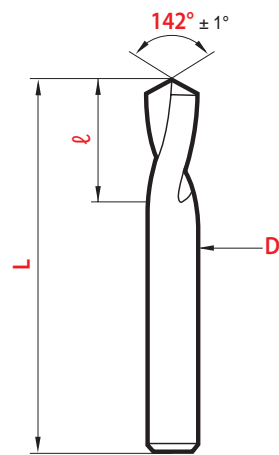

D		L	ℓ	142°			142°		
h7*	± 1	+1	magafor 194	TIN 0894	Red'X 0994	L ± 1	ℓ +1	magaforce 8190	Hard'X 8190-H
2,0						40	8	30,54 €	34,06 €
3,0	50	10	16,43 €	20,68 €	22,49 €	45	10	27,52 €	31,02 €
4,0	52	12	17,63 €	21,90 €	23,71 €	50	12	32,41 €	35,87 €
5,0	60	15	18,85 €	23,71 €	24,93 €	50	15	37,25 €	40,75 €
6,0	66	20	19,46 €	26,15 €	27,36 €	50	18	41,49 €	44,99 €
6,35 (1/4")	66	20	21,58 €	28,33 €	29,54 €	50	18	45,16 €	48,64 €
8,0	79	25	23,71 €	31,02 €	32,83 €	60	23	58,54 €	63,24 €
9,52 (3/8")	89	25	25,83 €	34,47 €	36,72 €	70	24	84,21 €	90,00 €
10,0	89	25	26,75 €	35,87 €	37,69 €	70	24	86,46 €	91,21 €
12,0	102	30	36,49 €	49,25 €	51,68 €	70	24	120,68 €	127,69 €
12,7 (1/2")	102	30	38,33 €	50,97 €	52,90 €	70	24	130,46 €	138,65 €
15,87 (5/8")	115	35	54,11 €	71,44 €	74,18 €	80	26	201,05 €	210,39 €
16,0	115	35	54,73 €	71,75 €	75,40 €	80	26	202,32 €	211,61 €
20,0	131	40	104,59 €	128,91 €	134,99 €				

Hard-X
Jusqu'à
up to
Hasta
Fino a 67 HRC

* CARBURE CARBIDE METAL DURO METALLO DURO = h5



Forets à pointer NC • NC spotting drill

Brocas de puntear • Punte a centrare

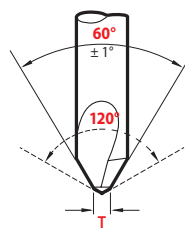
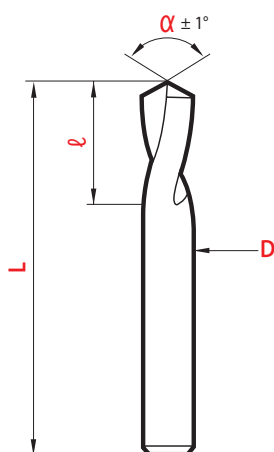
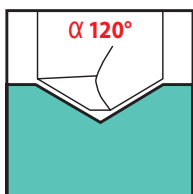
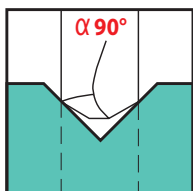
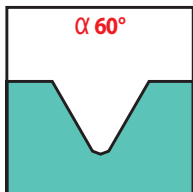

60°

magafor standard

α 60°

D x d	L	ℓ	T*	magafor 191	Red'X 0991
h6	± 1	+1			
4,0	52	12	0,8	54,73 €	60,80 €
5,0	60	15	0,9	57,77 €	63,85 €
6,0	66	20	1,0	60,80 €	69,93 €
8,0	79	25	1,3	63,85 €	76,01 €
10,0	89	25	1,6	66,89 €	82,10 €
12,0	102	30	2,0	72,97 €	91,21 €
16,0	115	35	3,0	109,45 €	136,81 €
20,0	131	40	3,5	182,43 €	224,97 €

*T = angle ángulo Angulo 120°

Coupe à gauche Left hand cut

Corte a izquierdas

Elica sinistra

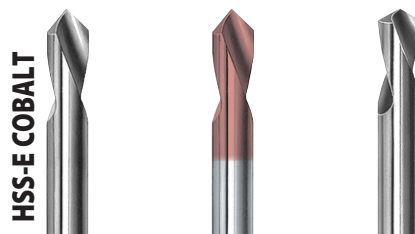

magafor standard

α 90°

90°

120°

D x d	L	ℓ	magafor 192	Red'X 0992	magafor 193
h6	± 1	+1			
3,0	50	10	30,41 €	36,49 €	30,41 €
4,0	52	12	36,49 €	42,56 €	36,49 €
5,0	60	15	42,56 €	48,64 €	42,56 €
6,0	66	20	48,64 €	57,77 €	48,64 €
8,0	79	25	54,73 €	66,89 €	54,73 €
10,0	89	25	60,80 €	76,01 €	60,80 €
12,0	102	30	72,97 €	91,21 €	
16,0	115	35	115,53 €	142,90 €	

Extra courts Extra short

Extra cortas

Extra corta



D h7		L	ℓ	classic 19-A	classic 19-B	classic 19-AG	classic 19-BG
inch	mm	± 1	+1				
1/8"	3,17	32	9,5	10,94 €	10,94 €	18,16 €	18,16 €
3/16"	4,76	35	12,5	12,16 €	12,16 €	20,19 €	20,19 €
1/4"	6,35	38	16	14,29 €	14,29 €	23,74 €	23,74 €
5/16"	7,93	38	16	15,20 €	15,20 €	25,26 €	25,26 €
3/8"	9,52	51	25,5	17,02 €	17,02 €	28,28 €	28,28 €
7/16"	11,11	51	25,5	20,98 €	20,98 €		
1/2"	12,7	51	25,5	25,24 €	25,24 €	41,90 €	41,90 €
5/8"	15,87	57	28,5	34,35 €	34,35 €	57,13 €	57,13 €
3/4"	19,05	57	28,5	69,93 €	69,93 €	116,08 €	116,08 €
7/8"	22,22	64	32	94,26 €	94,26 €		
1"	25,4	64	32	103,99 €	103,99 €	172,59 €	172,59 €

Queue cône Morse

Morse taper shank

Mango

Cono Morse

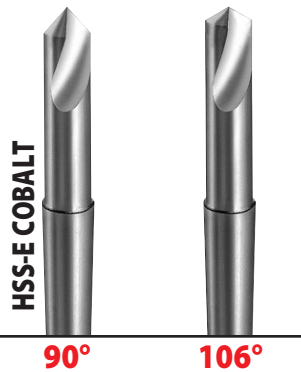

90°

106°

D	L	ℓ1	ℓ2	MORSE	magafor	magafor
h10	± 1	+1	+1	N°	198	1906
10,0	130	25	64	1	102,76 €	
12,0	130	30	64	1	107,62 €	119,79 €
16,0	148	35	68	2	132,55 €	148,37 €
20,0	148	40	68	2	158,10 €	176,33 €
25,0	171	45	72	3	217,69 €	240,79 €

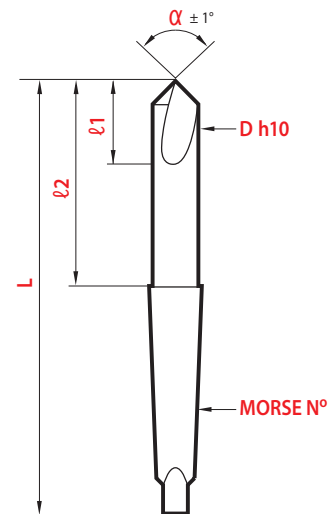

COMBI-mag

Outils multi-fonctions

multi-function tools

Herramientas multi-función

Utensili multi-funzione

90°

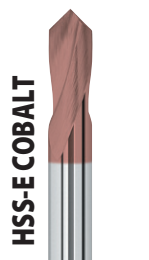

COMBI-mag

D h7	L	ℓ	T*	Red'X	
inch	mm	± 1	+1	007	
	3	50	6	0,3	18,85 €
1/8"	3,17	50	6	0,3	18,85 €
	4	52	8	0,4	19,46 €
3/16"	4,76	60	9	0,5	20,06 €
	5	60	10	0,5	20,06 €
	6	66	12	0,6	23,71 €
1/4"	6,35	66	12	0,6	24,93 €
5/16"	7,93	79	14	0,8	27,67 €
	8	79	14	0,8	27,67 €
3/8"	9,52	89	16	1	31,62 €
	10	89	16	1	32,83 €
	12	102	18	1,2	42,56 €
1/2"	12,7	102	19	1,3	44,99 €
	14	115	21	1,4	60,21 €
5/8"	15,87	115	24	1,6	62,64 €
	16	115	24	1,6	62,64 €

*T = 0,1 D Épaisseur d'âme Web thickness Espesor del núcleo Spessore in punta del nocciolo

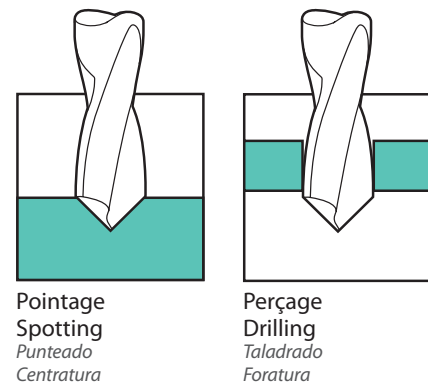

Pointage
Spotting
Punteado
Centratura

Perçage
Drilling
Taladrado
Foratura

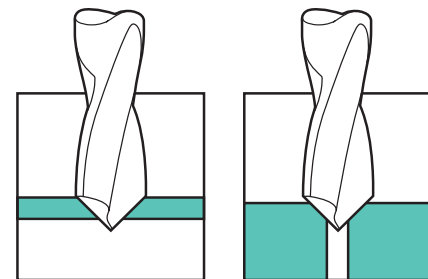

Chanfrein direct
Direct chamfer
Chafilanes directos
Svasatura rapida

Chanfreinage
Chamfering
Chafilado
Sbavatura

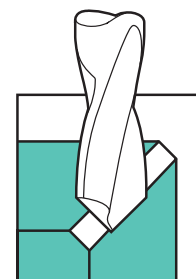

Chanfrein longitudinal
Longitudinal chamfer
Chafilanes longitudinales
Smussi longitudinali

Promo-kits



6 COMBI-mag Ø 4 - 5 - 6 - 8 - 10 - 12
007 166,61 €

Forets à pointer NC • NC spotting drill

Brocas de puntear • Punte a centrare

Longs Long

Largas
Lunghe

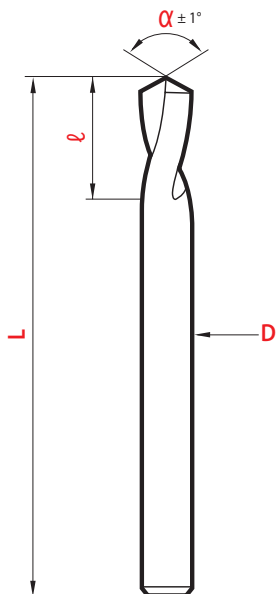
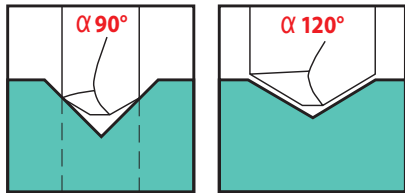

magafor standard			90°	120°	90°	120°
D	L	ℓ	magaforce 8197	magaforce 8199	Hard'X 8197-H	Hard'X 8199-H
h5	± 1	+1				
1,0	50	6	88,17 €		91,83 €	
2,0	60	8	72,97 €		76,61 €	
3,0	80	10	79,04 €		82,70 €	
4,0	100	12	91,21 €	91,21 €	94,86 €	94,86 €
5,0	120	15	97,29 €	97,29 €	100,93 €	100,93 €
6,0	140	20	109,45 €	109,45 €	114,32 €	114,32 €
6,35 (1/4")	140	22	121,62 €	121,62 €	126,48 €	126,48 €
8,0	140	25	133,78 €	133,78 €	138,65 €	138,65 €
9,52 (3/8")	170	25	224,97 €	224,97 €	231,07 €	231,07 €
10,0	170	25	231,07 €	231,07 €	237,14 €	237,14 €
12,0	170	30	291,87 €	291,87 €	301,00 €	301,00 €
12,70 (1/2")	170	35	304,03 €	304,03 €	313,16 €	313,16 €
15,87 (5/8")	200	35	437,81 €	437,81 €	449,98 €	449,98 €
16,0	200	35	437,81 €	437,81 €	449,98 €	449,98 €
19,05 (3/4")	200	40	668,88 €	668,88 €	684,08 €	684,08 €
20,0	200	40	699,28 €	699,28 €	714,49 €	714,49 €

Hard-X
Jusqu'à
up to
Hasta
Fino a 67 HRC

De dureté à chaud élevée (3500 HV), ce revêtement présente une très grande stabilité thermique et une excellente protection contre la chaleur et l'usure. Idéal pour les usinages à sec - à très grande vitesse - dans les aciers traités et matrices.

With a high hardness (3500 HV), this coating shows a high thermal stability and an excellent protection against heat and wear. Ideal for dry machining - high speed cut - in treated steels and dies.

Con una alta dureza (3500 HV) este recubrimiento proporciona una alta estabilidad térmica y una excelente protección contra el calor y el desgaste. Ideal para mecanizado en seco - a alta velocidad - en aceros tratados y de matrices.

Con notevole durezza a caldo (3500 HV) questo rivestimento presenta una grande stabilità termica ed un'eccellente protezione contro il calore e l'usura. Ideale per le lavorazioni a secco - a velocità elevate - negli acciai trattati e nelle matrici.

magafor *Le choix! The choice! La elección! La scelta!*

Matière Material Materiale	HSS	HSS-E COBALT	HSS-E COBALT + Red'X	CARBURE CARBIDE Metallo duro	CARBURE CARBIDE + Hard'X
Dureté Hardness Durezza	63 HRC	65 HRC	65 HRC + 2300 HV	1800 HV	1800 HV + 3500 HV
Utilisation Use Utilización Impiego	Petites séries Small series Pequeñas series Piccole serie	Production intensive Intensive production Producción intensiva Produzione intensiva		Aciers trempés Treated steels Aceros tratados Acciai temprati	
Page Pagina	➤ 37-40-43		➤ 37~ 43		➤ 36-39-42

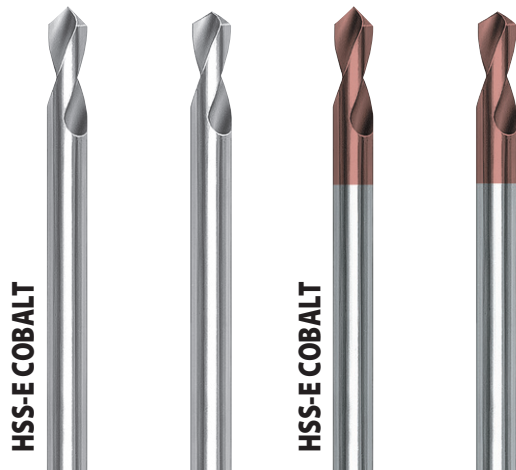

magafor standard

			90°	120°	90°	120°
D	L	ℓ	magafor 197	magafor 199	Red'X 0997	Red'X 0999
h6	± 1	+1				
1,0	50	6	57,77 €	57,77 €	62,64 €	62,64 €
2,0	60	8	48,64 €	48,64 €	58,37 €	58,37 €
3,0	80	10	42,56 €	42,56 €	47,42 €	47,42 €
4,0	100	12	39,52 €	39,52 €	44,39 €	44,39 €
5,0	120	15	42,56 €	42,56 €	47,42 €	47,42 €
6,0	140	20	45,61 €	45,61 €	50,47 €	50,47 €
6,35 (1/4")	140	22	48,64 €	48,64 €	54,73 €	54,73 €
8,0	140	25	51,68 €	51,68 €	58,98 €	58,98 €
9,52 (3/8")	170	25	69,93 €	69,93 €	78,44 €	78,44 €
10,0	170	25	72,97 €	72,97 €	82,70 €	82,70 €
12,0	170	30	90,00 €	90,00 €	100,93 €	100,93 €
12,70 (1/2")	170	35	93,63 €	93,63 €	104,59 €	104,59 €
15,87 (5/8")	200	35	130,92 €	130,92 €	140,52 €	140,52 €
16,0	200	35	133,25 €	133,25 €	142,86 €	142,86 €
19,05 (3/4")	200	40	167,87 €	167,87 €	185,33 €	185,33 €
20,0	200	40	171,66 €	171,66 €	191,45 €	191,45 €
25,4 (1")	200	45	215,88 €	215,88 €		

Performances
 p. 17

Red-X
 Jusqu'à
 up to
 Hasta
 Fino a 55 HRC



α				90°	120°
inch	D h7 mm	L ± 1	ℓ +1	classic 19-C	classic 19-D
1/4"	6,35	66 (2-5/8")	22	13,37 €	13,37 €
		102 (4")	22	34,65 €	34,65 €
		140 (5-1/2")	22	42,88 €	42,88 €
3/8"	9,52	79 (3")	25	16,12 €	16,12 €
		127 (5")	25	54,73 €	54,73 €
		178 (7")	25	67,49 €	67,49 €
1/2"	12,7	95 (3-3/4")	35	24,02 €	24,02 €
		152 (6")	35	67,49 €	67,49 €
		203 (8")	35	84,52 €	84,52 €
5/8"	15,87	111 (4-3/8")	35	32,52 €	32,52 €
		200 (8")	35	113,47 €	113,47 €
		229 (9")	35	142,56 €	142,56 €
3/4"	19,05	127 (5")	40	62,33 €	62,33 €
		200 (8")	40	148,38 €	148,38 €
		254 (10")	40	177,48 €	177,48 €
1"	25,4	138 (5-7/16")	45	95,46 €	95,46 €
		200 (8")	45	190,58 €	190,58 €
		254 (10")	45	229,55 €	229,55 €

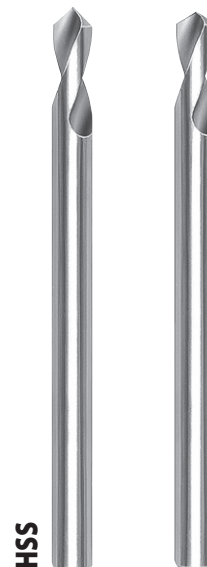

HSS

Centrage • Pointage / Centering • Spoting
 Centratúra • Centratúra NC / Centrado • Punteado