

Mini broches à HAUTE VITESSE COOLSPEED

Nouvelles mini broches révolutionnaires à très haute vitesse jusqu'à 75 000 tr/min!
 Toolles adaptables à tous les portes outils standards du marché pour des fraises à queue Ø 3, 4 et 6mm.

2 systèmes d'entraînement:

- **EMULSION**, pression 10 ~ 60 bars, rotation jusqu'à 75 000 tr/min.
- **AIR**, pression 4 ~ 5 bars, rotation jusqu'à 50 000 tr/min.

Transformez vos centres d'usinage en centres UGV !

HIGH SPEED mini spindles COOLSPEED

New revolutionary high-speed spindles up to 75,000 rpm!
 Toolles are adaptable to all standard sealed tool holders on the market and support microtool shanks for Ø 3, 4 and 6mm.

2 driving systems:

- **EMULSION**, pressure 10 ~ 60 bar, rotating up to 75 000 rpm.
- **AIR MIST**, pressure 4 ~ 5 bar, rotation up to 50 000 rpm.

Transform your machining center in UGV center !

Minihusillo de ALTA VELOCIDAD COOLSPEED

¡Nuevos husillos revolucionarias de muy alta velocidad hasta 75.000 rpm!
 Toolles adaptables a todas las portaherramientas estándar del mercado para fresas de mango Ø 3, 4 y 6mm.

2 sistemas de accionamiento:

- **EMULSIÓN**, presión 10 ~ 60 bar, rotación hasta 75.000 tr/min.
- **AIRE**, presión 4 ~ 5 bar, rotación hasta 50.000 tr/min.

Transforme sus centros de mecanizado en UGV centros!

Mini-mandrini AD ALTA VELOCITA' COOLSPEED

Nuovi mandrini rivoluzionari ad altissima velocità fino a 75.000 giri/min!
 Toolles adattabile a tutti i porta utensili standard del mercato per frese a coda Ø 3, 4 e 6mm.

2 sistemi di azionamento:

- **IDRAULICO**, pressione 10 ~ 60 bar, rotazione fino a 75.000 giri/min.
- **PNEUMATICO**, pressione 4 ~ 5 bar, rotazione fino a 50 000 giri/min

Trasformate i vostri centri di lavoro in UGV centri !

magafor 

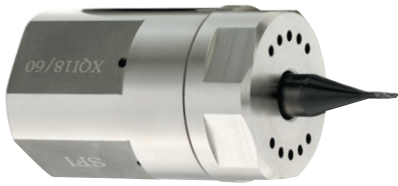

EMULSION

Nombre de tours - Puissance / Pression émulsion
 Revolution number - Output Power / Emulsion pressure
 Número de vueltas - Potencia de salida / Presión de la emulsión
 Numero di giri - Potenza in uscita / Pressione idraulica

Nombre de tours
 (1000t/min)
 Revolution number
 (1000tr/min)

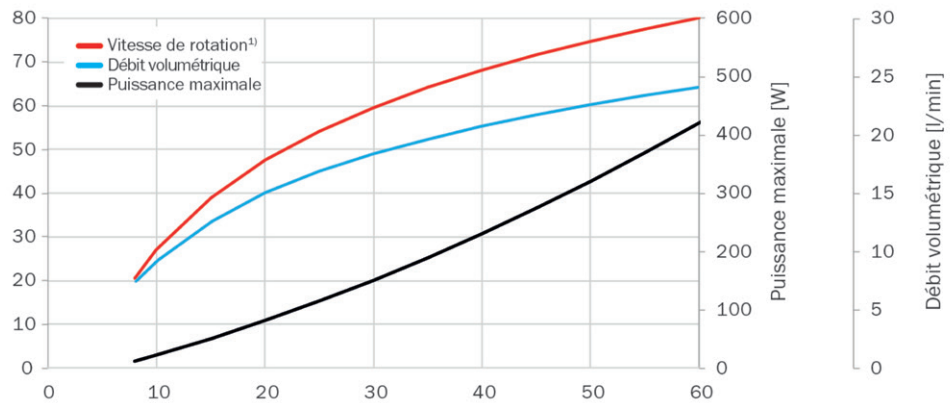

Pression émulsion / Emulsion pressure (bar)
 Presión de la emulsión / Pression émulsion
 Ajout d'huile - air mist - 5/10 gouttes - drops / minute

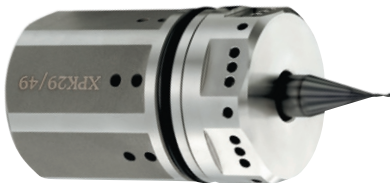

AIR*

Nombre de tours - Puissance / Pression d'AIR
 Revolution number - Output Power / Air pressure
 Número de vueltas - Potencia de salida / Presión del aire
 Numero di giri - Potenza in uscita / Pressione pneumatica
 Ajout d'huile - air mist - 5/10 gouttes - drops / minute

Nombre de tours
 (1000t/min)
 Revolution number
 (1000tr/min)

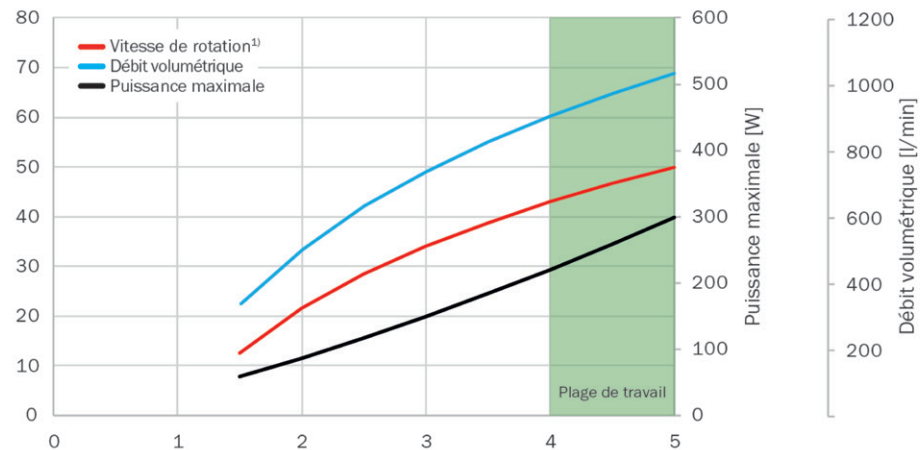

Pression d'air / Air pressure (bar)
 Presión del aire / Pressione pneumatica



Mini broches • Mini spindles

Minihusillos • Mini mandrini

À haute vitesse

High speed

De alta velocidad

Ad alta velocità

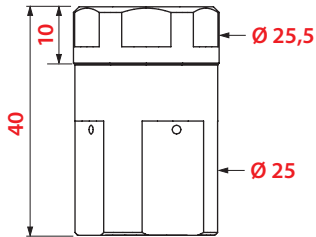

AIR / EMULSION

Porte-outils compatibles pour fraises à queues Ø 3 - 4 - 6 mm
 Tool holders suitable for shank end mills Ø 3 - 4 - 6 mm
 Portaherramientas compatibles con fresas de mango Ø 3 - 4 - 6 mm
 Portautensili compatibili per frese con codolo Ø 3 - 4 - 6 mm



Type Tipo	Code	€
EMULSION	TTBC1304	799,00 €
AIR	TTGC1312	799,00 €

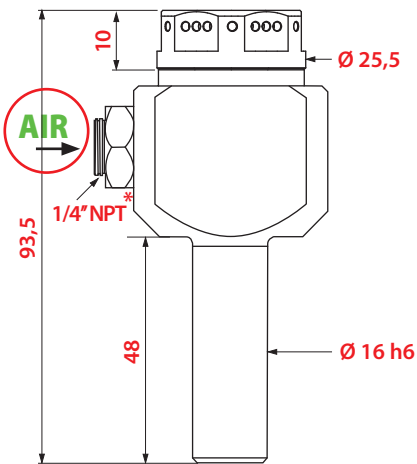

EMULSION



Type Tipo	Code	€
EMULSION	TTBE1304	1149,00 €
AIR	TTGE1312	1149,00 €

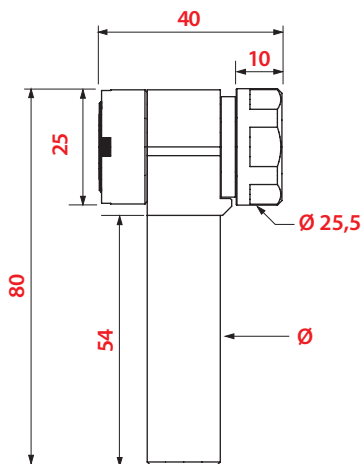

AIR / EMULSION



Type Tipo	Ø	Code	€
EMULSION	16	TTBP1304	1149,00 €
AIR	16	TTGP1312	1149,00 €

Pince / Turbine
Crowbar/Turbine
Pinza / Girante



Ø queue shank mango codolo	Composition Composición Composizione	TRK13M
3	2 roulements + 1 turbine	45,39 €
4	2 bearings + 1 turbine	45,39 €
6	2 rodamientos + 1 turbina 2 cuscinetti + 1 girante	45,39 €

Aide au montage
Installation aid
Ayuda al montaje
Aiuto al montaggio



Ø queue shank mango codolo	Composition Composición Composizione	TAK13M
3		161,77 €
4	Socle d'assemblage + guide	161,77 €
6	Assembly devide + bridge	161,77 €
3 - 4 - 6	Utensilio de ensamble + guía Dispositivo di montaggio + guida	249,00 €

* Ø 3-4-6

Manomètre pression huile
Oil pressure gauge
Manómetro de presión de aceite
Manometro pressione idraulico

Pour le contrôle de la pression d'huile à la broche de la machine.

For oil pressure control at the spindle of the machine.

Para el control de la presión de aceite en el husillo de la máquina.

Per il controllo della pressione dell'olio al mandrino della macchina.



TPK25
331,67 €

Accessoires
Accessories
Accesorios
Accessori

L'équipement consiste en une mini-broche + une pince/turbine et une aide au montage

The equipment consists of a mini-pin + clamp/turbine and mounting aid.

El equipo consiste en un minihusillo + una pinza/turbina y una utensilio de ayuda de montaje.

L'attrezzatura consiste in un mini-mandrino + una pinza/girante con montaggio agevolato.

Montage Assembly
Montaje Montaggio

