

1	Function	PJMA-13
1.1	Input Voltage Range	PJMA-13
1.2	Inrush Current Limiting	PJMA-13
1.3	Overcurrent Protection	PJMA-13
1.4	Overvoltage Protection	PJMA-13
1.5	Thermal Protection	PJMA-13
1.6	Output Ripple and Ripple Noise	PJMA-13
1.7	Output Voltage Adjustment	PJMA-14
1.8	Isolation	PJMA-14
1.9	Remote ON/OFF	PJMA-14
1.10	Remote Sensing	PJMA-14
1.11	LV Alarm	PJMA-14
2	Series Operation and Parallel Operation	PJMA-14
2.1	Series Operation	PJMA-14
2.2	Parallel Operation	PJMA-14
3	Life Expectancy and Warranty	PJMA-14
4	Ground	PJMA-15
5	Options and Others	PJMA-15
5.1	Outline of Options	PJMA-15
5.2	Medical Isolation Grade	PJMA-21
5.3	Others	PJMA-21

1 Function

1.1 Input Voltage Range

- The input voltage range of the power supply is 85-264VAC (See SPECIFICATIONS for more details).
- The rated input voltage to comply with safety standards is 100-240VAC (50/60Hz).
- If the input voltage is out of the above range, the power supply may malfunction and/or fail.
- If the input voltage was changed dynamically, the output voltage change might be out of specifications.
- The power supply can work at the input voltage dip with the derating.

Table 1.1 IEC60601-1-2 Maximum output load factor

Voltage Dip	duration [ms]	PJMA300F	PJMA600F	PJMA1000F	PJMA1500F
100VAC→ 0VAC	20	100%	100%	100%	50%
100VAC→ 40VAC	100	50%	60%	10%	5%
100VAC→ 70VAC	500	100%	100%	100%	80%
240VAC→ 0VAC	20	100%	100%	100%	100%
240VAC→ 96VAC	100	100%	100%	100%	100%
240VAC→168VAC	500	100%	100%	100%	100%

1.2 Inrush Current Limiting

- Inrush current protection is built-in.
- If you need to use a switch on the input side, select one that can withstand an input inrush current.

●PJMA300F

- Thermistor is used in the inrush current limiting circuit. When you turn the power supply on and off repeatedly within a short period of time, have enough intervals for the power supply to cool down before being turned on again.

●PJMA600F, PJMA1000F, PJMA1500F

- Thyristor and TRIAC technique is used in the inrush current limiting circuit. When you turn the power supply on and off repeatedly within a short period of time, have enough intervals for the inrush current protection to become active.
- There will be primary inrush current and secondary inrush current flowing because thyristor and TRIAC technique is used for the inrush current limiting circuit.

1.3 Overcurrent Protection

- Overcurrent protection is built-in. It works at more than 105% of the rated output current. The power supply recovers automatically when the overcurrent condition is removed. Do not use the power supply under a short-circuit or overcurrent condition.

■Hiccup Operation Mode

When overcurrent protection works and the output voltage drops, the output voltage goes into hiccup mode so that the average output current can decrease.

1.4 Overvoltage Protection

- Overvoltage protection is built-in. If overvoltage protection works, shut down the input voltage, wait more than 3 minutes, and turn on the input voltage again to recover the output voltage. The recovery time varies depending on the input voltage, etc.

Remarks :

Avoid applying an overrated voltage to the output terminals as it may cause the power supply to malfunction or fail. In case the above-mentioned situation is expected in operating such loads as a motor, for example, consult us for advice.

1.5 Thermal Protection

- Thermal protection is built-in.

Thermal protection will work under the following conditions and the power supply will shut down.

- ①When the operating temperature and the output current greatly exceed the derating curve.
- ②When the built-in cooling fan stops or the air flow from the fan is obstructed.

If thermal protection works, switch off the input voltage and eliminate the conditions causing thermal protection to work. Allow enough time for the unit to cool off before switching on the input voltage again to recover the output voltage.

1.6 Output Ripple and Ripple Noise

- Output ripple noise may be influenced by the measuring environment. The measuring method shown in Fig. 1.1 is recommended.
- Output ripple and ripple noise is the value measured by the method shown in Fig.1.1.

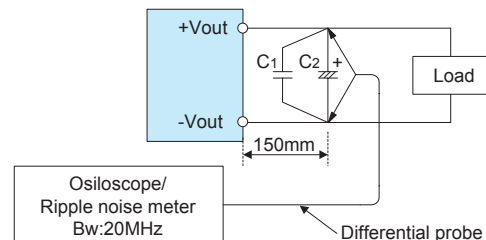

- C1 : Film capacitor 0.1µF
- C2 : Aluminum electrolytic capacitor 22µF

Fig.1.1 Measuring method of Ripple and Ripple Noise

Remarks :

When measuring output ripple or ripple noise with an oscilloscope, do not have the oscilloscope's GND cable cross the magnetic flux from the power supply. Otherwise there may be electrical potential generated on the GND cable and the measurement result may not be accurate.

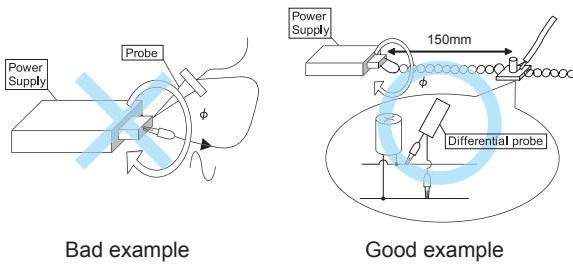

Fig.1.2 Example of measuring output ripple and ripple noise

1.7 Output Voltage Adjustment

- The output voltage can be adjusted within the specified range by turning the built-in potentiometer clockwise (up) or counterclockwise (down).
- Please operate the potentiometer slowly.
- With the option -V, the power supply comes with an external potentiometer instead of a built-in potentiometer. See "5 Options and Others" for more details.

1.8 Isolation

- For a receiving inspection, such as Hi-Pot test, gradually increase (decrease) the voltage for the start (shut down). Avoid using Hi-Pot tester with the timer because it may generate voltage a few times higher than the applied voltage, at ON/OFF of a timer.

1.9 Remote ON/OFF

- The -R option is available for these models. With the -R option, remote ON/OFF is possible. See "5 Options and Others" for more details.

1.10 Remote Sensing

● PJMA300F

- This model do not have the remote sensing function.

● PJMA600F, PJMA1000F, PJMA1500F

- The -W/-W1 option is available. With the -W/-W1 option, remote sensing is possible. See "5 Options and Others" for more details.

1.11 LV Alarm

● PJMA300F

- This model do not have the LV alarm function.

● PJMA600F, PJMA1000F, PJMA1500F

- The -W/-W1 option is available. With the -W/-W1 option, the power supply can give an LV alarm. See "5 Options and Others" for more details.

2 Series Operation and Parallel Operation

2.1 Series Operation

- The power supplies can be used in series connection. The output current in series operation must be lower than the rated current of the power supply with the lowest rated current among the power supplies connected in series. Make sure no current exceeding the rated current flows into a power supply.

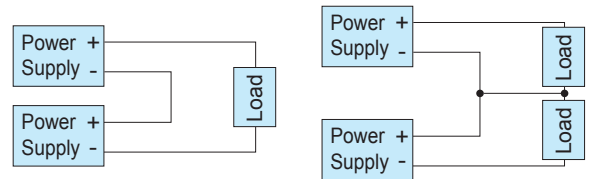

Fig.2.1 Examples of connecting in series operation

2.2 Parallel Operation

- Redundant operation is possible by wiring as shown below.

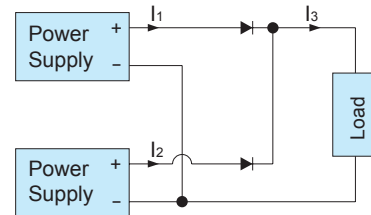

Fig.2.2 Example of redundancy operation

- Even a slight difference in output voltage can affect the balance between the values of I_1 and I_2 . Make sure the value of I_3 does not exceed the rated output current of the power supply.

$$I_3 \leq \text{the rated current value}$$

● PJMA300F, PJMA600F

- Parallel operation is not possible.

● PJMA1000F, PJMA1500F

- The -W option is available. With the -W option, parallel operation is possible. See "5 Options and Others" for more details.

3 Life Expectancy and Warranty

■ Life Expectancy

The life expectancy of the power supply is shown below.

Table 3.1 Life Expectancy

Mounting	Cooling method	Average ambient temperature	Life Expectancy [years]	
			Io ≤ 50%	Io ≤ 100%
All direction	Forced air cooling (internal fan)	Ta = 30°C	10	7
		Ta = 40°C	7	5
		Ta = 50°C	5	3

*This lifetime includes a built-in fan lifetime.

■The life expectancy time (R (t) = 90%) of the built-in fan depends on the operating condition as shown in Fig. 3.1.

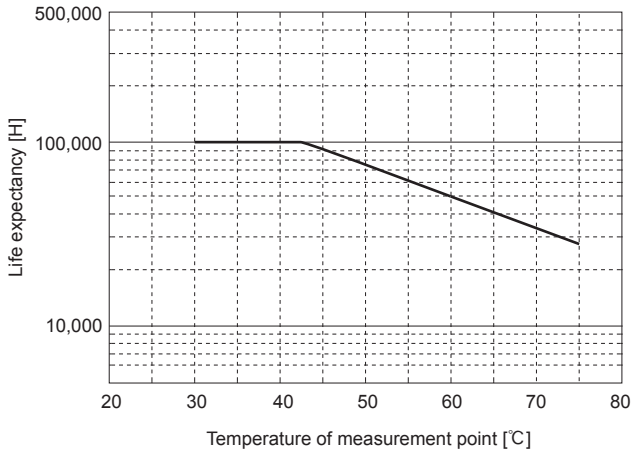

Fig.3.1 Life expectancy of fan

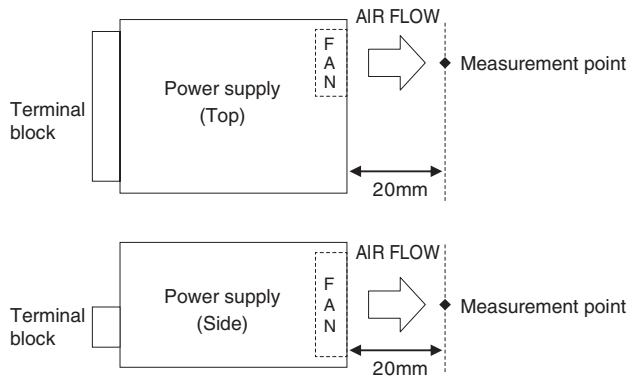

Fig.3.2 Temperature of measurement point for fan lifetime (PJMA300F, PJMA600F)

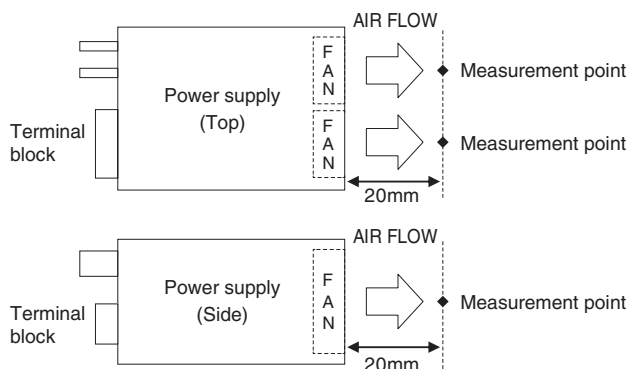

Fig.3.3 Temperature of measurement point for fan lifetime (PJMA1000F, PJMA1500F)

■Warranty

The maximum warranty period is 5 years as shown in Table 3.2.

Table 3.2 Warranty

Mounting	Cooling method	Average ambient temperature	Warranty [years]	
			Io ≤ 50%	Io ≤ 100%
All direction	Forced air cooling (internal fan)	Ta = 40°C	5	5
		Ta = 50°C	5	3

4 Ground

■When installing the power supply, make sure the FG terminal and the chassis (at more than 2 places) are connected to the safety earth ground.

5 Options and Others

5.1 Outline of Options

●-C

- With the -C option, the internal PCB has a conformal coating for anti-humidity.

●-G

- With the -G option, the leakage current of the power supply is reduced.
- The differences between the option -G models and the standard models are shown below.

Table 5.1 Low leakage current type

	PJMA300F, PJMA600F, PJMA1000F, PJMA1500F
Leakage Current (AC240V 60Hz)	0.1mA max
Conducted Noise	N/A
Output Ripple Noise	Please contact us for details about Ripple Noise

* This is the result of measurement of the testing board with capacitors of 22μF and 0.1μF placed at 150 mm from the output terminals by a 20 MHz oscilloscope or a ripple-noise meter equivalent to Keisoku-Giken RM104.

●-V

- With the -V option, the power supply comes with an external potentiometer connector instead of a built-in potentiometer.
- The appearance of the -V models is different from that of the standard models. Contact us for more details.
- Note that if the power supply is turned on with CN3 open, the output voltage will make a big drop.

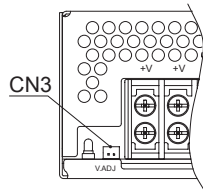

Fig.5.1 Front view of option-V (PJMA600F)

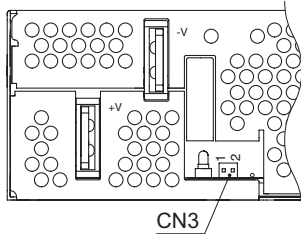

Fig.5.2 Front view of option-V (PJMA1000F)

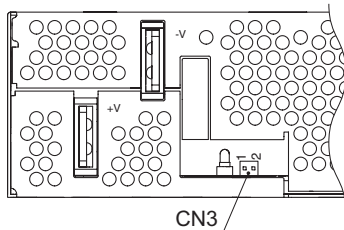

Fig.5.3 Front view of option-V (PJMA1500F)

● -R

- The -R option makes it possible to switch on or off the output by applying voltage to the RC terminals of the power supply from an external power source.
- The appearance of the option -R models is different from that of the standard models.
- Designated harnesses for the RC terminals are available for sale. See Optional Parts for more details.
- The -R option models have extra connectors. Please contact us for more details.

Table 5.2 Remote on/off operating conditions

Model Name	Built-in Resistor Ri [Ω]	Voltage between RC and RCG [V]		Input Current [mA]
		Output ON	Output OFF	
PJMA300F, PJMA600F, PJMA1000F, PJMA1500F	780	4.5 - 12.5	0 - 0.5	(20max)

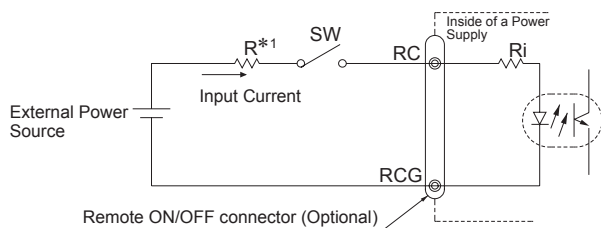

Fig.5.4 Example of using a remote ON/OFF circuit

*1 If the external voltage applied to the RC terminals is 4.5 -12.5V, the current limiting resistor is not necessary. If the voltage applied is more than 12.5V, make sure the current limiting resistor R is used.

The value of the current limiting resistor is obtained by the following formula:

$$R[\Omega] = \frac{V_{cc} - (1.1 + R_i \times 0.005)}{0.005} \quad V_{cc} : \text{External Power Source}$$

*Note that reversed connection damages internal components of the power supply.

*The remote control circuit is isolated from input, output and FG.

■ Remote on/off control for PJMA300F

- Remote control connectors are added. Contact us for more details.
- Make sure there is an interval of more than 2 seconds in the on/off cycle. If the interval is shorter, the start-up time may become longer (approx. 2 seconds).

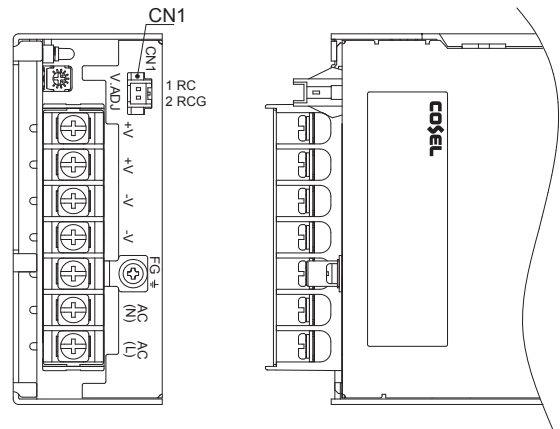

Fig.5.5 Example of option -R (PJMA300F)

Table 5.3 Pin configuration and function of CN1 (PJMA300F)

PIN	FUNCTION
1	RC :Remote ON/OFF
2	RCG:Remote ON/OFF (GND)

Table 5.4 Mating connectors and terminals on CN1 (PJMA300F)

Connector	Housing	Terminal	Mfr
CN1	XARR-02V	XAP-02V-1	SXA-001T-P0.6

■ Remote on/off control for PJMA600F, PJMA1000F and PJMA1500F

- The appearance of the -R option model is different from that of the standard model as CN1 is added. Contact us for more details.

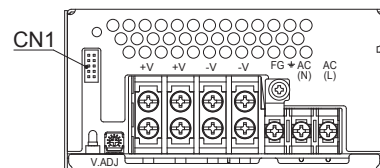

Fig.5.6 Front view of option -R (PJMA600F)

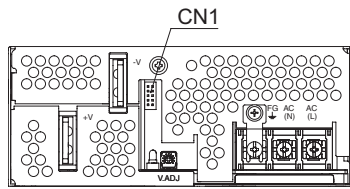

Fig.5.7 Front view of option -R (PJMA1000F)

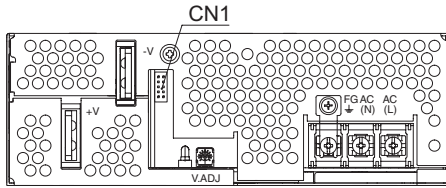

Fig.5.8 Front view of option -R (PJMA1500F)

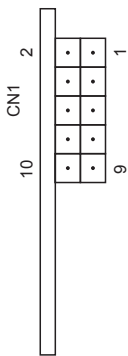

Fig.5.9 Pin number

Table 5.5 Pin configuration and function of CN1

PIN	FUNCTION
1	- :N.C.
2	- :N.C.
3	RC :Remote ON/OFF
4	RCG:Remote ON/OFF(GND)
5	- :N.C.
6	- :N.C.
7	- :N.C.
8	- :N.C.
9	- :N.C.
10	- :N.C.

Table 5.6 Mating connectors and terminals on CN1

Connector	Housing	Terminal	Mfr
CN1	S10B-PHDSS	PHDR-10VS	Reel :SPHD-002T-P0.5
			Loose :BPHD-001T-P0.5 :BPHD-002T-P0.5

● -W (PJMA1000F, PJMA1500F)

- The -W option models provide remote sensing, low output voltage alarm (LV alarm), and parallel operation.
- The appearance of the -W option model is different from that of the standard mode. Contact us for more details.
- Designated harnesses are available for sale. See Optional Parts.
- The differences from the standard model are shown in Table 5.7.

Table 5.7 Specification differences of Option -W

Load regulation	1.5 times of standard spec.
Ripple	1.5 times of standard spec.
Ripple noise	1.5 times of standard spec.

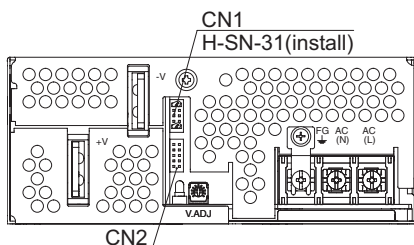

Fig.5.10 Front view of option -W (PJMA1000F)

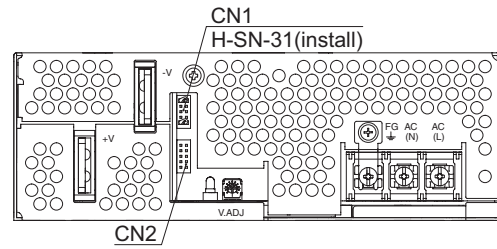

Fig.5.11 Front view of option -W (PJMA1500F)

Table 5.8 Pin configuration and function of CN1 and CN2

PIN	FUNCTION
1	+M :Self sensing terminal (Don't wire for external function)
2	+S :+Sensing
3	- :N.C.
4	- :N.C.
5	LV :LV alarm
6	LVG :LV alarm (GND)
7	CB :Current balance
8	- :N.C.
9	-M :Self sensing terminal (Don't wire for external function)
10	-S :-Sensing

Fig.5.12 Pin number

Table 5.9 Mating connectors and terminals on CN1 and CN2

Connector	Housing	Terminal	Mfr
CN1 CN2	S10B-PHDSS	PHDR-10VS	Reel :SPHD-002T-P0.5
			Loose :BPHD-001T-P0.5 :BPHD-002T-P0.5

■ LV alarm

The operating conditions of the LV alarm are shown in Table 5.10. The internal circuit of the LV alarm is shown in Fig. 5.13. The LV alarm is isolated from input, output, and FG.

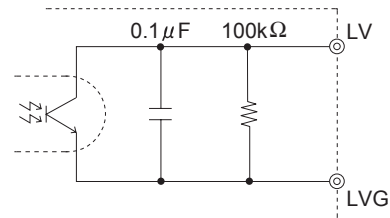

Fig.5.13 LV internal circuit

Table 5.10 LV alarm operating conditions

	Alarm	Output of alarm
LV	If the output voltage drops or stops, the LV and LVG terminals give an alarm signal. Note : ① In case of overcurrent, the alarm signal will be unstable. ② The alarm signal won't be given in parallel operation if OR diodes are not used.	Open collector method Good : Low (0 - 0.8V, 10mA max) Fail : High or Open 50V 10mA max

■ Parallel operation

For parallel operation, please take the following steps:

- ① (Before wiring) set the output voltage of each unit to the desired value. The output voltage difference between the units must be less than 0.1V or 1% of the rated output voltage, whichever is smaller.
- ② Wire the power supplies as shown in Fig. 5.14. Make sure the output wires of the unit connected in parallel are of the same length and the same type.
- ③ Make sure the total output current does not exceed the value determined by the following formula:

$$\left[\begin{matrix} \text{Output current in} \\ \text{parallel operation} \end{matrix} \right] = \left[\begin{matrix} \text{The rated} \\ \text{current per unit} \end{matrix} \right] \times (\text{Number of unit}) \times 0.85$$

*Make sure the current drawn from each unit is less than the rated output current.

- When adjusting the output voltage after wiring, repeat the above-mentioned steps (① to ③).
- If the number of units in parallel increases, the input current increases as well. Make sure the input equipment and wires have enough current capacity.
- The maximum number of units for parallel connection is 5.
- Master-Slave operation is not possible.

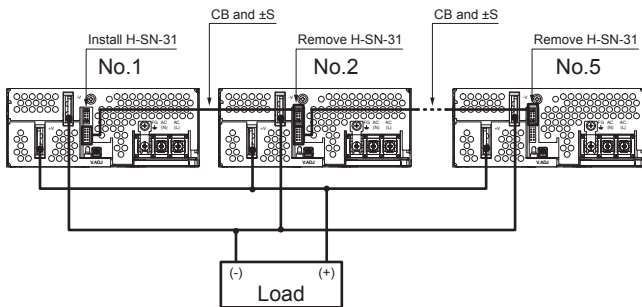

Fig.5.14 Parallel operation condition (Example of PJMA1000F,PJMA1500F)

- If the output current is less than 10% of the rated output current, the output voltage may fluctuate. The required minimum current is different depending on the model and the number of units in parallel. Consult us for more details.
- If the length of the output wires of each unit is different, the output current from each unit will be unbalanced. Make sure to use output wires of the same length for all units in parallel.

■ Remote sensing

- These models are equipped with a remote sensing function. If the remote sensing is not used, the following terminals of CN1 must be shorted:

- +S and +M
- S and -M

When the power supply is shipped from our factory, a designated harness (H-SN-31) is attached to CN1. If remote sensing is not used, there is no need to remove the harness.

- The wire connection when remote sensing is used or not used is shown in Fig. 5.15 - Fig. 5.16.

- When using remote sensing, make sure to finish wiring +S and -S first. The designated harness is available for sale. Contact us for more details.

- When using remote sensing, pay attention to the following:

- ① Wiring must be done carefully. If there is bad connection on the load lines due to loose screws, etc., the load current flows into the sensing lines and the internal circuit of the power supply may be damaged.
- ② Make sure the wires between the load and the power supply are thick enough to keep the line drop less than 0.3V.
- ③ If the sensing wires are long, place C1 and R1 across the load lines.
- ④ Use a twisted pair wire or a shielded wire for the sensing lines.
- ⑤ Do not draw the output current from +M, -M, +S or -S.
- ⑥ The impedance of the wiring or the load may cause the output voltage to oscillate or fluctuate.

Test to confirm remote sensing works fine. If the output voltage is found to be unstable, the following methods are recommended:

- Remove the remote sensing line on the minus side and short -S and -M.
- Use C1, R1, and R2.

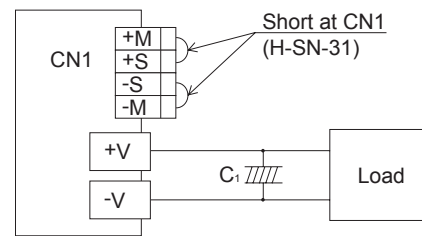

Fig.5.15 When not using remote sensing function

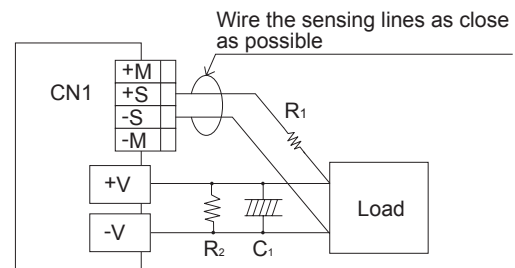

Fig.5.16 When using remote sensing function

● -W1 (PJMA600F, PJMA1000F, PJMA1500F)

- The -W1 option models provide remote sensing, low output voltage alarm (LV alarm).
- The appearance of the -W1 option model is different from that of the standard mode. Contact us for more details.
- Designated harnesses are available for sale. See Optional Parts.
- The differences from the standard model are shown in Table 5.11.

Table 5.11 Specification differences of Option -W1

Load regulation	1.5 times of standard spec.
Ripple	1.5 times of standard spec.
Ripple noise	1.5 times of standard spec.

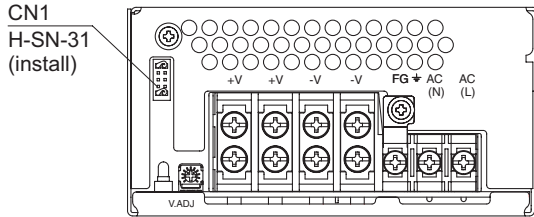

Fig.5.17 Front view of option -W1 (PJMA600F)

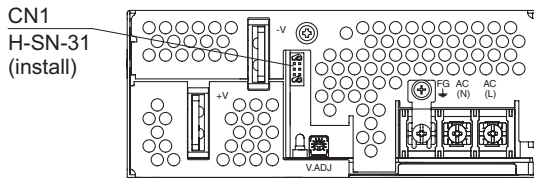

Fig.5.18 Front view of option -W1 (PJMA1000F)

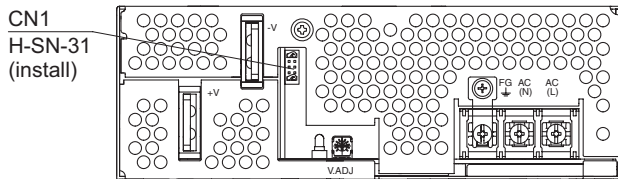

Fig.5.19 Front view of option -W1 (PJMA1500F)

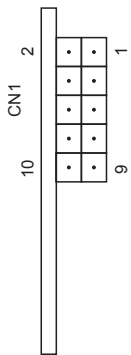

Fig.5.20 Pin number

Table 5.12 Pin configuration and function of CN1

PIN	FUNCTION
1	+M :Self sensing terminal (Don't wire for external function)
2	+S :+Sensing
3	- :N.C.
4	- :N.C.
5	LV :LV alarm
6	LVG :LV alarm (GND)
7	- :N.C.
8	- :N.C.
9	-M :Self sensing terminal (Don't wire for external function)
10	-S :-Sensing

Table 5.13 Mating connectors and terminals on CN1

Connector	Housing	Terminal	Mfr
CN1	S10B-PHDSS PHDR-10VS	Reel :SPHD-002T-P0.5	J.S.T.
		Loose :BPHD-001T-P0.5	
		:BPHD-002T-P0.5	

■LV alarm

The operating conditions of the LV alarm are shown in Table 5.14. The internal circuit of the LV alarm is shown in Fig. 5.21. The LV alarm is isolated from input, output, and FG.

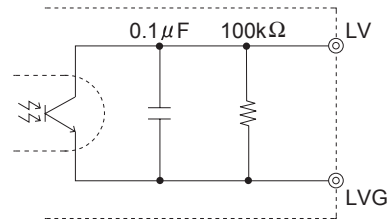

Fig.5.21 LV internal circuit

Table 5.14 LV alarm operating conditions

	Alarm	Output of alarm
LV	If the output voltage drops or stops, the LV and LVG terminals give an alarm signal. Note : ①In case of overcurrent, the alarm signal will be unstable. ②The alarm signal won't be given in parallel operation if OR diodes are not used.	Open collector method Good : Low (0 - 0.8V, 10mA max) Fail : High or Open 50V 10mA max

■Remote sensing

These models are equipped with a remote sensing function. If the remote sensing is not used, the following terminals of CN1 must be shorted:
+S and +M
-S and -M
When the power supply is shipped from our factory, a designated harness (H-SN-31) is attached to CN1. If remote sensing is not used, there is no need to remove the harness.

- The wire connection when remote sensing is used or not used is shown in Fig. 5.22 - Fig. 5.23.
- When using remote sensing, make sure to finish wiring +S and -S first. The designated harness is available for sale. Contact us for more details.
- When using remote sensing, pay attention to the following:
 - ① Wiring must be done carefully. If there is bad connection on the load lines due to loose screws, etc., the load current flows into the sensing lines and the internal circuit of the power supply may be damaged.
 - ② Make sure the wires between the load and the power supply are thick enough to keep the line drop less than 0.3V.
 - ③ If the sensing wires are long, place C1 and R1 across the load lines.
 - ④ Use a twisted pair wire or a shielded wire for the sensing lines.
 - ⑤ Do not draw the output current from +M, -M, +S or -S.
 - ⑥ The impedance of the wiring or the load may cause the output voltage to oscillate or fluctuate.

Test to confirm remote sensing works fine. If the output voltage is found to be unstable, the following methods are recommended:

- Remove the remote sensing line on the minus side and short -S and -M.
- Use C1, R1, and R2.

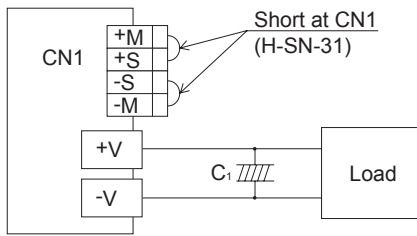

Fig.5.22 When not using remote sensing function

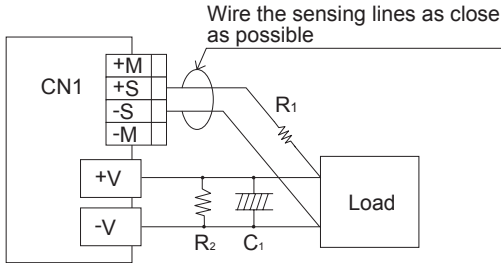

Fig.5.23 When using remote sensing function

●-F4

- The -F4 option models come with a low-speed fan to reduce the fan noise.
- The differences from the standard fan versions are shown below.
- FAN may stop at 10% load or less.

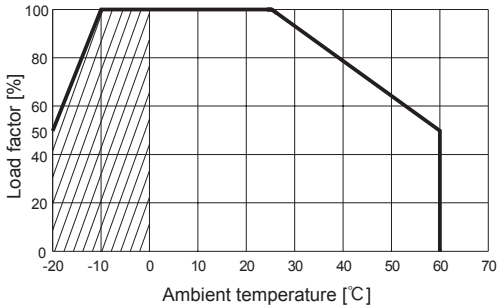

Fig.5.24 Ambient temperature derating curve for PJMA300F (Option-F4)

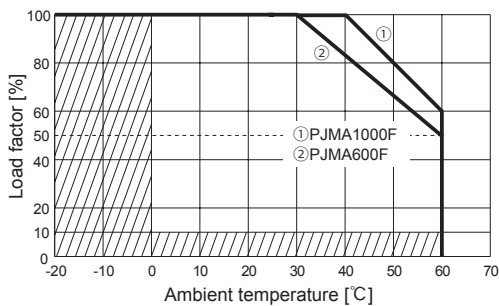

Fig.5.25 Ambient temperature derating curve for PJMA600F and PJMA1000F (Option-F4)

*The specification of ripple and ripple noise changes in shaded area.

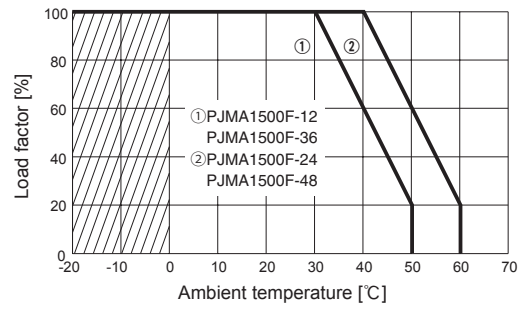

Fig.5.26 Ambient temperature derating curve for PJMA1500F (Option-F4)

Table 5.15 Life Expectancy of option -F4 (PJMA300F, PJMA600F)

Mounting	Cooling method	Average ambient temperature	Life Expectancy [years]	
			Io ≤ 50%	Io ≤ 100%
All direction	Forced air cooling (internal fan)	Ta = 20°C	7	5
		Ta = 30°C	5	5

* This lifetime includes a built-in fan lifetime.

Table 5.16 Life Expectancy of option -F4 (PJMA1000F, PJMA1500F)

Mounting	Cooling method	Average ambient temperature	Life Expectancy [years]	
			Io ≤ 50%	Io ≤ 100%
All direction	Forced air cooling (internal fan)	Ta = 20°C	10	10
		Ta = 30°C	10	10
		Ta = 40°C	10	5

* This lifetime includes a built-in fan lifetime.

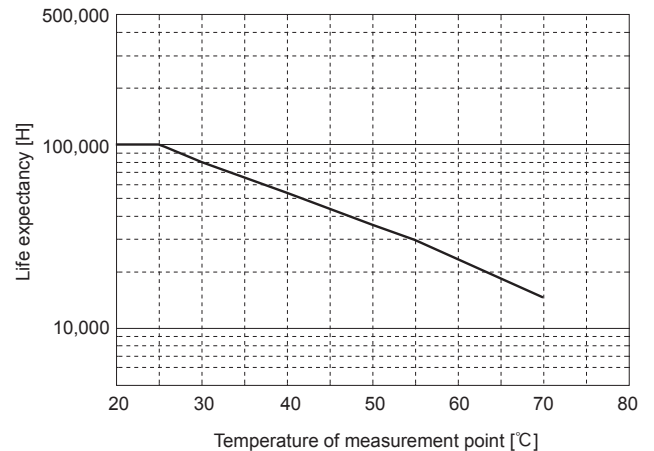

Fig.5.27 Life Expectancy of fan R(t)=90% (-F4)

Table 5.17 Warranty (-F4)

Mounting	Cooling method	Average ambient temperature	Warranty [years]	
			Io ≤ 50%	Io ≤ 100%
All direction	Forced air cooling (internal fan)	Ta = 20°C	5	5
		Ta = 30°C	5	3

5.2 Medical Isolation Grade

■ PJMA series fit 2MOPP

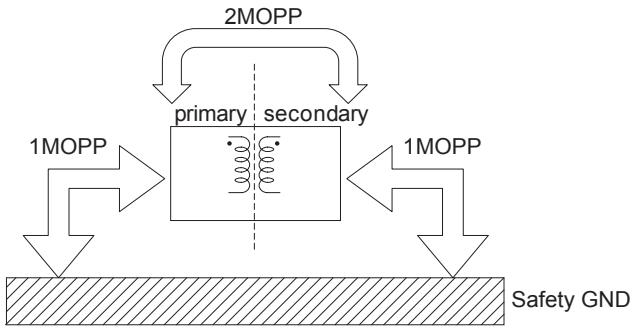

Fig.5.28 Medical Isolation Grade

5.3 Others

- Note that the case of the power supply remains hot for a while after it is turned off.
- If large capacitors are connected to the output terminals (load side), the output voltage may stop or become unstable. Consult us for advice.
- If the power supply is turned off at no load, the output voltage remains for a few minutes as the power supply is designed for low internal power consumption. Be careful of electrical shock at the time of maintenance.
- If the built-in cooling fan in PJMA300F/600F/1000F/1500F stops, the built-in thermal protection may work and the output voltage may stop. Please check fan rotation periodically, to enhance the system reliability.