

BACKER IMMERSION HEATERS FOR LIQUID HEATING WITH ELEMENT TUBES IN ACIDPROOF STAINLESS STEEL



Properties

Backer standard range of screw plug immersion/ insertion heaters in stock are suitable as heat sources for instance in domestic water heaters, calorifiers, electric boilers, vessels and industrial baths.

The heaters consists of 3 pieces Backer tubular heating elements brazed to a screw plug.

It could be fitted with different accessories such as terminal box, thermostat, safety temperature limiter, tube and insulation for flow-through heater, socket for assembly etc.

Technical specification

Material Tubular elements Ø8,5 mm in acidproof stainless steel EN 1.4404/AISI 316L
Screw plug G2" (R50, 60 mm) in brass
Tube for thermostat/temp.limiter Ø12x0,7 length 187 mm for IU 31R and 260 mm for others

Inactive length 100±10 mm for art. 25203875xx, 60±6 mm for others

Electric connection M4

Assembly Kit with gasket and connection parts included

Max working temperature 120°C

Max working pressure 9 bar

Manufacturing standard Backer 40579311 CE

Standards SS 4330701, SS-EN 60335-1, UL-1030, ISO 6469-3

Power tolerance +5% / -10%

Surface power density Approx. 6-11 W/cm² depending on type

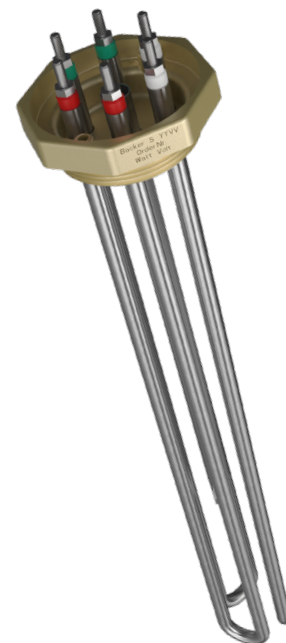

Type U

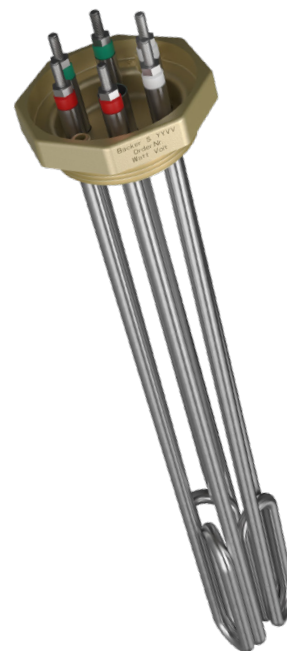

Type IDU

Standard assortment

Type	Power	Voltage	Insertion length	Design	Article
IU	W	V	Max mm		no
IU31R	1500	230/400	180	U	2520391501
IU3R	2000	230/400	260	U	2520391502
IU34R	3000	230/400	280	U	2520548001
IU36R	4500	230/400	390	U	2520548002
IU39R	6000	230/400	390	IDU	2520548003
IU311R	9000	3x400	390	IDU	2520548004
IU3R	9000	3x400	755	U	2520548005
IU3R	12000	3x400	750	U	2520387504
IU3R	15000	3x400	900	IDU	2520387505
IU315R	15000	3x400	1260	U	2530397706
IU3R	20000	3x400	900	IDU	2520387506
IU3R	23300	3x400	900	IDU	2520387507

BACKER IMMERSION HEATERS FOR LIQUID HEATING WITH ELEMENT TUBES IN ACIDPROOF STAINLESS STEEL



Type, U

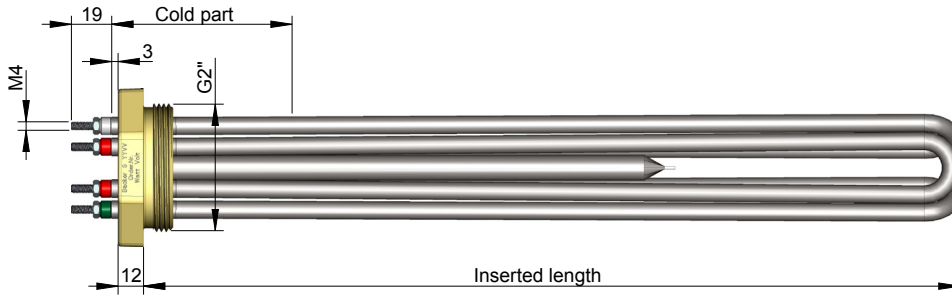

Type, IDU

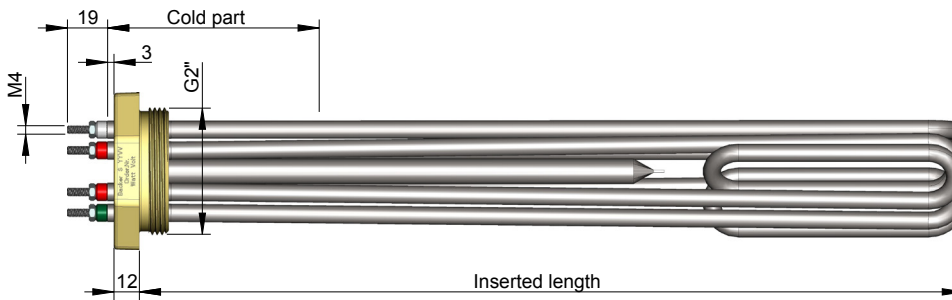

Circuit diagram/ connection alternatives*

1500W-6000W

9000W-23300W

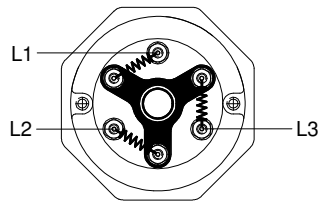
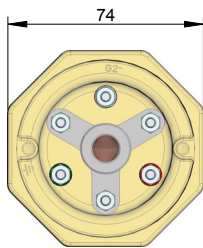

Star connection Y 3x400V

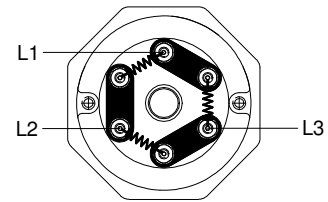
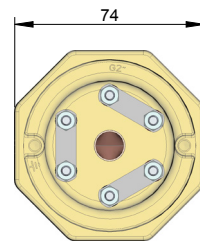

Delta connection D 3x400V

All electric connections and energizing components, must be done by a qualified electrician.

Options

- Terminal boxes, thermostats and safety temperature limiters, different options
- Tube and insulation for flow-through heater, different options
- Socket key G2" article no 1160143201
- Nut G2" in brass article no 1140485405