





**CHETO<sup>®</sup>**

CNC DEEP HOLE DRILLING WITH MILLING

innovative  
**MACHINE TOOLS**

CE

# Location

---

## CHETO TECHNOLOGICAL CENTER:

Área de Acolhimento Empresarial  
UI-Loureiro, Lotes 13-21  
3720-070 Loureiro, Oliveira de Azeméis  
Portugal  
GPS: 40°48'00.5"N | 8°30'35.3"W

## CONTACT US:

T. +351 256 247 970  
E. [info@cheto.eu](mailto:info@cheto.eu)

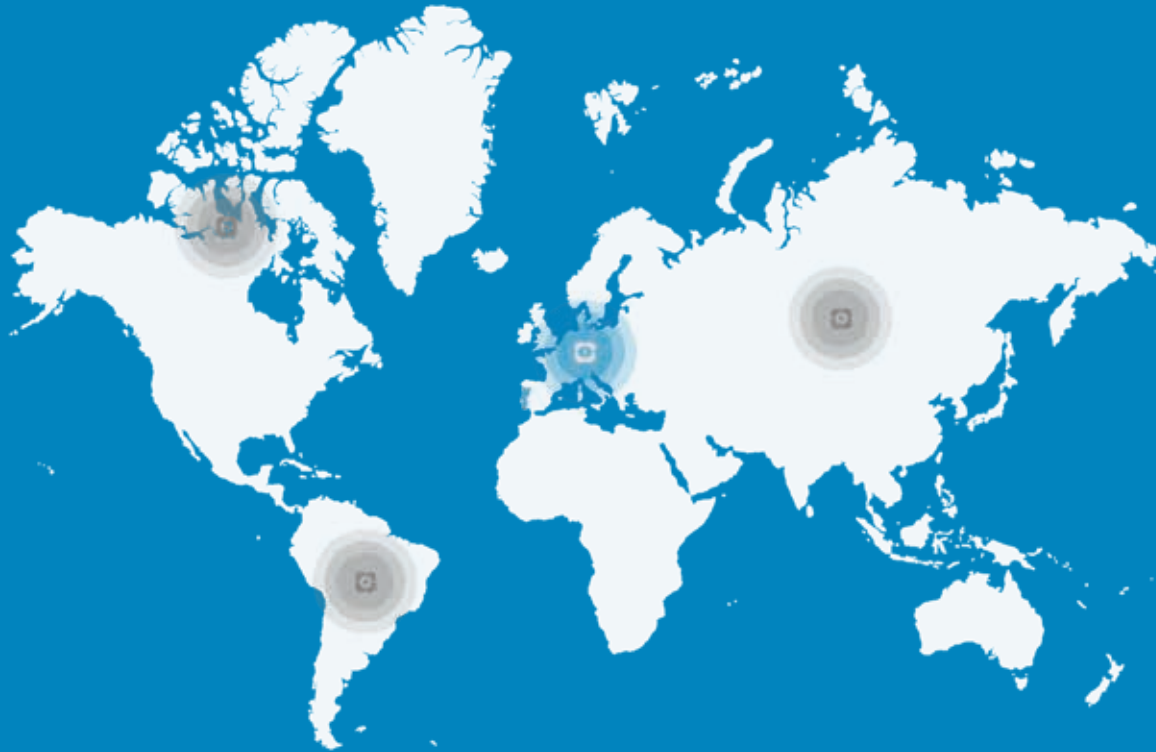

**WORLDWIDE PRESENCE**

■

**DEEP SOLUTIONS**  
INNOVATIVE CONCEPT  
TO OPTIMIZE  
DEEP HOLE DRILLING,  
STANDARD DRILLING  
AND MILLING

■





## INNOVATIVE machine tools

CHETO was officially established in 2009, when the founders started a project to fully develop a deep hole drilling and milling machine-tool up to 7-axis, specialized for the mold making and energy industry.

Since then, a continuous improvement and investigation allowed CHETO to offer the market a versatile product with high levels of accuracy and reliability.

This concept quickly positioned CHETO as a world-renowned brand. With machines sold in four continents, it is our goal to keep improving and innovating, to offer a highly competitive and value-creating product.



# CHETO HYBRID CONCEPT

deep hole drilling



90 SECONDS



milling

**60%**  
reduction in drilling time

**90%**  
reduction on parts' set-up time

**20%**  
reduction in mold delivery time

\*comparing with traditional process

IXN3000 | Registered design



## CHETO All in one



DEEP HOLE DRILLING MACHINE



RADIAL DRILLING MACHINE



MILLING MACHINE



TAPPING MACHINE

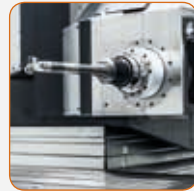

BORING MACHINE

### Working all around the part in a single setup (mold & die)

PLANING/SHAPING

BORING

THREADING

REAMING

ROUGHING

REFRIGERATION CIRCUITS

### Why choose us?

1. Innovative concept for moldmakers and service companies;
2. Deep hole drilling, standard drilling, milling, tapping, boring in a single machine;
3. Eliminates setup operations in mold manufacturing;
4. Excellent quality/price ratio;
5. Reduction of time and costs;
6. Embedded drilling and machining processes, minimizing human errors;
7. Brand of excellence, internationally recognized in the mold industry;
8. **CHETO** machines represent an excellent investment for their multitasking features that otherwise were directed at other machines less specific and less adequate to the needs and requirements of the mold manufacturing and other services;
9. Follows the concepts of the industry 4.0;
10. Service App for the technical service support and remote assistance;
11. Machine Monitoring iDLC + Production Data + Cutting Data + Predictive.

# IXN 1000 | 2000 | 3000 | 4000\*

6 AXES | 7 AXES

## Standard Equipment

- CNC HEIDENHAIN TNC 640
- Electronic handwheel
- Digital drives
- Nitrogen double counterweight
- Absolute linear encoders in axes X, Y and Z
- Absolute angular encoders in axis A and B
- Automatic chip conveyor
- Kinematics / RTCP
- Rigid tapping
- Quick change between drilling/milling
- Coolant tank with automatic filtering
- Submerged pumps for oil recirculation
- High-pressure pump up to 80 bar, 100 l/min | 1,160 psi, 26.5 gal/min
- Telescopic covers in all axes (except drilling axis)
- Complete cover with doors, laminated glass windows and acrylic ceiling
- Spindle tilting +35°/-25°

## Optional Equipment

- CNC FAGOR 8065
- CNC SIEMENS SINUMERIK ONE
- Wise software system
- ATC up to 120 tools (up to 600 mm | 23.6 in tool length)
- ATC Gun drill up to 5 tools<sup>1</sup>
- Table with zero clamping system
- Automatic curtain on load/unload door
- Spindle gearbox
- Y axis = 1500 mm | 59.1 in
- W axis = 2100 mm | 82.7 in
- V axis up to 1900 mm | 74.8 in
- Oil mix collector
- Electronic touch probe and tool preset laser system
- AC for electrical cabinet
- Immersion chiller for oil/emulsion
- Pack Connectivity i4.0

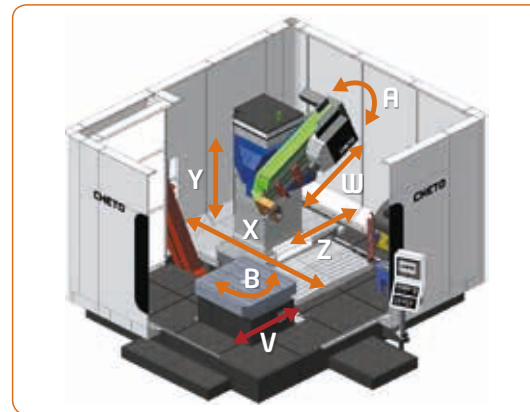

IXN3000 | Registered design



CHETO CNC deep hole drilling with milling



## Technical Data

	1000		2000		3000	
<b>CNC Axis</b>						
W drilling one stroke	1700 mm	67 in	1700 mm	67 in	1700 mm	67 in
X longitudinal travel	1000 mm	39.4 in	2000 mm	78.7 in	3000 mm	118.1 in
Y vertical travel	1000 mm	39.4 in	1200 mm	47.2 in	1200 mm	47.2 in
Z cross travel	800 mm	31.5 in	800 mm	31.5 in	800 mm	31.5 in
B table rotation	360°		360°		360°	
A tilting rotation	+35°/-25°		+35°/-25°		+35°/-25°	
<b>Drilling capacity</b>						
Max. drilling stroke W+Z	1700+800 mm	67+31.5 in	1700+800 mm	67+31.5 in	1700+800 mm	67+31.5 in
Drilling capacity	ø5-40 mm	ø0.2-1.58 in	ø5-40 mm	ø0.2-1.58 in	ø5-40 mm	ø0.2-1.58 in
<b>Milling capacity</b>						
Milling	300 cm <sup>3</sup> /min	18.3 in <sup>3</sup> /min	400 cm <sup>3</sup> /min	24.4 in <sup>3</sup> /min	500 cm <sup>3</sup> /min	30.5 in <sup>3</sup> /min
Rigid tapping	M30		M32		M34	
Helical threading	Standard		Standard		Standard	
<b>Spindle</b>						
Spindle taper	ISO 50 DIN 69871		ISO 50 DIN 69871		ISO 50 DIN 69871	
Speed	0-6000 rpm		0-6000 rpm		0-6000 rpm	
Power	15/25 kW	20/33 hp	20/30 kW	26/40 hp	24/38 kW	32/51 hp
Torque	134/223 Nm	99/165 ft-lbs	178/267 Nm	131/197 ft-lbs	214/338 Nm	158/249 ft-lbs
<b>Automatic rotary table</b>						
Table size	1300x1300 mm	51.2x51.2 in	1600x1300 mm	63.0x51.2 in	1800x1800 mm	70.9x70.9 in
Resolution	0,001°		0,001°		0,001°	
Max. load in rotation	10 Ton	22,047 lbs	20 Ton	44,093 lbs	30 Ton	66,139 lbs
<b>Layout dimensions</b>						
Total weight	29 Ton	63,934 lbs	34 Ton	74,957 lbs	39 Ton	85,980 lbs
Total weight <sup>2</sup> GDATC			40 Ton	89,600 lbs	45 Ton	100,800 lbs
<sup>3</sup> Foot print (WxL)	7140x5760 mm	281.1x226.8 in	8690x6160 mm	342.1x242.5 in	9520x7410 mm	374.8x291.7 in

\*Data to be provided on request

<sup>1</sup>More than 5 up on request<sup>2</sup>GunDrill Automatic Tool Changer<sup>3</sup>Approximated values, it depends on the final machine configuration

(Subject to modifications without prior notice)



# SiC 650 | 1000 | 1000 HD

6 AXES

MONOBLOCK CONCEPT

## Standard Equipment

- CNC HEIDENHAIN TNC 640
- Electronic handwheel
- Digital drives
- External status led indication
- Absolute linear encoders in axes X, Y and Z
- Absolute angular encoders in axis A and B
- Automatic chip conveyor
- 3+2 milling for SiC 650 | 1000
- 5 axis milling for SiC 1000 HD
- Kinematics / RTCP
- High-pressure pump up to 70 bar, 75 l/min | 1,015 psi, 19.5 gal/min
- Rigid tapping
- Quick change between drilling/milling
- Coolant tank with automatic filtering
- Pumps for oil recirculation
- Machine prepared to use emulsion or oil
- Complete cover with doors
- Automatic load/unload door
- Electronic Touch Probe
- Tool Preset Laser System
- WISE software system

## Optional Equipment

- CNC FAGOR 8065
- CNC SIEMENS SINUMERIK ONE
- Oil mix collector
- ATC up to 112 tools
- Table with zero clamping system
- ATC 76 tools, L=600 mm | 23.6 in
- High-pressure pump up to 100 bar, 75 l/min | 1,450 psi, 19.5 gal/min
- Pack Connectivity i4.0

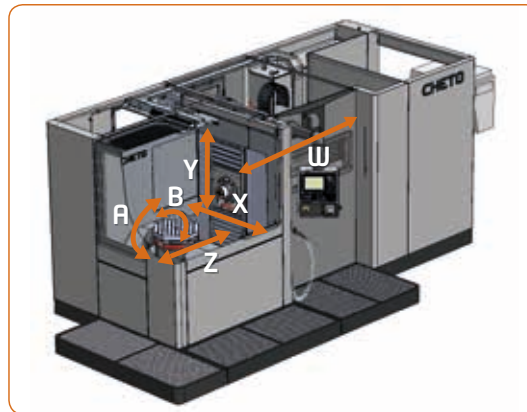

SiC | Registered design



Technical Data

	650		1000		1000 HD	
<b>CNC Axis</b>						
W drilling stroke	1100 mm	43.4 in	1100 mm	43.4 in	1400 mm	55.1 in
X longitudinal travel	650 mm	25.6 in	1000 mm	39.4 in	1200 mm	47.2 in
Y vertical travel	840 mm	33.1 in	840 mm	33.1 in	1100 mm	43.3 in
Z cross travel	500 mm	19.7 in	500 mm	19.7 in	700 mm	27.6 in
B table rotation	360°		360°		360°	
A table tilting rotation	+90°/-45°		+90°/-45°		+110°/-45°	
<b>Drilling capacity</b>						
Drilling capacity	ø3-25 mm	ø0.1-1.0 in	ø3-25 mm	ø0.1-1.0 in	ø3-32 mm	ø0.1-1.3 in
<b>Milling capacity</b>						
Milling	250 cm <sup>3</sup> /min	15.3 in <sup>3</sup> /min	250 cm <sup>3</sup> /min	15.3 in <sup>3</sup> /min	450 cm <sup>3</sup> /min	27.5 in <sup>3</sup> /min
Rigid tapping	M16	3/8"	M16	3/8"	M20	3/4"
Helical threading	Standard		Standard		Standard	
<b>Spindle</b>						
Spindle taper	HSK-A63		HSK-A63		HSK-A100 / SK 50 BIG +	
Speed	0-11,820 rpm		0-11,820 rpm		0-12,000 rpm	
Power	21/26 kW	28/35 hp	21/26 kW	28/35 hp	45/49,5 kW	60.3/66.4 hp
Torque	80.2/101.7 Nm	59/75 ft-lbs	80.2/101.7 Nm	59/75 ft-lbs	285/315 Nm	210.2/232.3 ft-lbs
<b>Automatic rotary table</b>						
Table size	500x500 mm	20x20 in	500x500 mm	20x20 in	ø800 mm	31x31 in
Resolution	0,001°		0,001°		0,001°	
Max. load in rotation	750 kg / 600 kg	1653 lbs / 1323 lbs	750 kg / 600 kg	1653 lbs / 1323 lbs	1200 kg / 925 kg	2646 lbs / 2039 lbs
<b>Layout dimensions</b>						
Total weight	13 Ton	28,660 lbs	15 Ton	33,600 lbs	18 Ton	40,320 lbs
<sup>1</sup> Foot print (WxL)	6840x2901 mm	267.3x124.4 in	6840x3300 mm	267.3x129.9 in	8216x4555 mm	323.5x179.3 in



SiC650 | 1000

Power / Torque Diagram

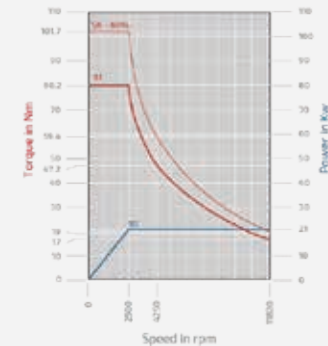

SiC1000 HD

Power / Torque Diagram

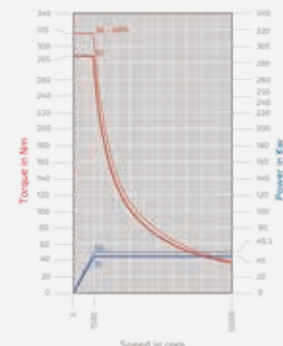

<sup>1</sup>Approximated values, it depends on the final machine configuration

(Subject to modifications without prior notice)



### Standard Equipment

- CNC FAGOR 8060-M
- Electronic handwheel
- Digital drives
- Nitrogen double counterweight
- Absolute linear encoders in axes X, Y and Z
- Absolute angular encoders in axis B
- Automatic chip conveyor
- Kinematics / RTCP
- Rigid tapping
- Quick change between drilling/milling
- Coolant tank with automatic filtering
- Submerged pumps for oil recirculation
- High pressure pump 80 bar, 100 l/min | 1,160 psi, 26.5 gal/min
- Telescopic covers in all axes (except drilling axis)
- Complete cover with doors, laminated glass windows and acrylic ceiling

### Optional Equipment

- CNC HEIDENHAIN TNC 640
- CNC SIEMENS SINUMERIK ONE
- Wise software system
- ATC up to 120 tools (up to 600 mm | 23.6 in tool length)
- ATC Gun drill up to 5 tools
- AC for electrical cabinet
- Y axis = 1500 mm | 59.1 in
- W axis = 2100 mm | 82.7 in
- Oil mix collector
- Electronic Touch Probe
- Tool Preset Laser System
- Immersion chiller for oil/emulsion
- Spindle Gearbox
- Pack Connectivity i4.0

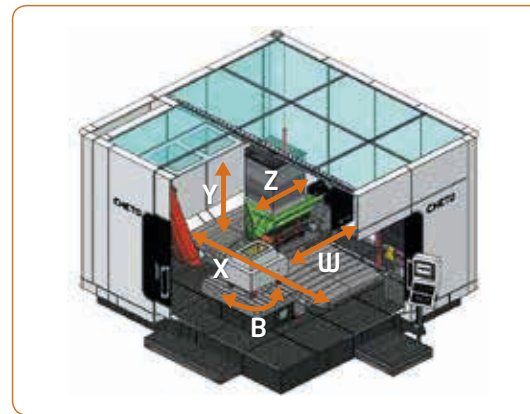

Technical Data

	1000		2000		3000	
<b>CNC Axis</b>						
W drilling one stroke	1700 mm	67.0 in	1700 mm	67.0 in	1700 mm	67.0 in
X longitudinal travel	1000 mm	39.4 in	2000 mm	78.7 in	3000 mm	118.1 in
Y vertical travel	1000 mm	39.4 in	1200 mm	47.2 in	1200 mm	47.2 in
Z cross travel	800 mm	31.5 in	800 mm	31.5 in	800 mm	31.5 in
B table rotation	360°		360°		360°	
<b>Drilling capacity</b>						
Max. drilling stroke W+Z	1700+800 mm	67.0+31.5 in	1700+800 mm	67.0+31.5 in	1700+800 mm	67.0+31.5 in
Drilling capacity	ø5-40 mm	ø0.2-1.58 in	ø5-40 mm	ø0.2-1.58 in	ø5-40 mm	ø0.2-1.58 in
<b>Milling capacity</b>						
Milling	300 cm³/min	18.3 in³/min	400 cm³/min	24.4 in³/min	500 cm³/min	30.5 in³/min
Rigid tapping	M30		M32		M34	
Helical threading	Standard		Standard		Standard	
<b>Spindle unit</b>						
Spindle taper	ISO 50 DIN 69871		ISO 50 DIN 69871		ISO 50 DIN 69871	
Speed	0-4500 rpm		0-4500 rpm		0-4500 rpm	
Power	11/15 kW	15/20 hp	15/22 kW	20/30 hp	22/33 kW	30/45 hp
Torque	140/200 Nm	103/148 ft-lbs	191/287 Nm	141/212 ft-lbs	280/420 Nm	207/310 ft-lbs
<b>Automatic rotary table</b>						
Table size	1300x1300 mm	51.2x51.2 in	1600x1300 mm	63.0x51.2 in	1800x1800 mm	70.9x70.9 in
Resolution	0,001°		0,001°		0,001°	
Max. load in rotation	10 Ton	22,047 lbs	20 Ton	44,093 lbs	30 Ton	66,139 lbs
<b>Layout dimensions</b>						
Total weight	21 Ton	46,298 lbs	23 Ton	50,707 lbs	28 Ton	61,730 lbs
<sup>1</sup> Foot print (WxL)	5000x5510 mm	196.8x216.9 in	5970x5510 mm	235.0x216.9 in	6725x5850 mm	264.8x230.3 in



<sup>1</sup>Approximated values, it depends on the final machine configuration

(Subject to modifications without prior notice)



### Standard Equipment

- CNC FAGOR 8060-M
- Electronic handwheel
- Digital drives
- Nitrogen double counterweight
- Absolute linear encoders in axis X, Y and Z
- Absolute angular encoders in axis B
- Telescopic covers in all axes (except drilling axis)
- RTCP/Kinematics
- Rigid tapping
- Quick change between drilling/milling
- Coolant tank with automatic filtering
- Submerged pumps for oil recirculation
- High pressure pump 70 bar, 90 l/min | 1,015 psi, 23.8 gal/min
- Automatic chip conveyor
- Complete cover with doors, laminated glass windows and acrylic ceiling

### Optional Equipment

- CNC HEIDENHAIN TNC 620
- CNC SIEMENS SINUMERIK ONE
- Wise software system
- ATC automatic tool change (24 tools)
- Oil mix collector
- Electronic Touch Probe
- Tool Preset Laser System
- AC for electrical cabinet
- Immersion chiller for oil/emulsion
- Pack Connectivity i4.0

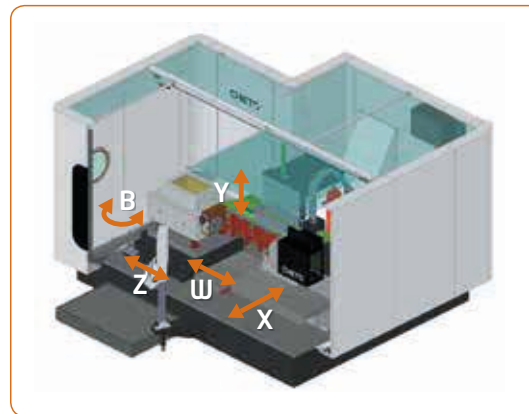

## Technical Data

	1000		1500	
<b>CNC Axis</b>				
W drilling one stroke	1550 mm	61.0 in	1550 mm	61.0 in
X longitudinal travel	1000 mm	39.4 in	1500 mm	59.1 in
Y vertical travel	600 mm	23.6 in	600 mm	23.6 in
Z cross travel	500 mm	19.7 in	500 mm	19.7 in
B table rotation	360°		360°	
<b>Drilling capacity</b>				
Max. drilling stroke W+Z	1550+500 mm	61.0+19.7 in	1550+500 mm	61.0+19.7 in
Drilling capacity	ø4-25 mm	ø0.16-0.99 in	ø4-25 mm	ø0.16-0.99 in
<b>Milling capacity</b>				
Milling	250 cm³/min	15.3 in³/min	250 cm³/min	15.3 in³/min
Rigid tapping	M22		M22	
Helical threading	Standard		Standard	
<b>Spindle unit</b>				
Spindle taper	ISO 40 DIN 69871		ISO 40 DIN 69871	
Speed	0-6000 rpm		0-6000 rpm	
Power	11 kW	14.8 hp	11 kW	14.8 hp
Torque	140/191 Nm	103.3/140.9 ft-lbs	140/191 Nm	103.3/140.9 ft-lbs
<b>Automatic rotary table</b>				
Table size	1000x1000 mm	39.4x39.4 in	1000x1000 mm	39.4x39.4 in
Resolution	0,001°		0,001°	
Max. load in rotation	5 Ton	11,200 lbs	5 Ton	11,200 lbs
<b>Layout dimensions</b>				
Total weight	16 Ton	35,840 lbs	17 Ton	38,080 lbs
¹Foot print (WxL)	4783x5277 mm	188.3x207.8 in	4783x5277 mm	188.3x207.8 in

¹Approximated values, it depends on the final machine configuration

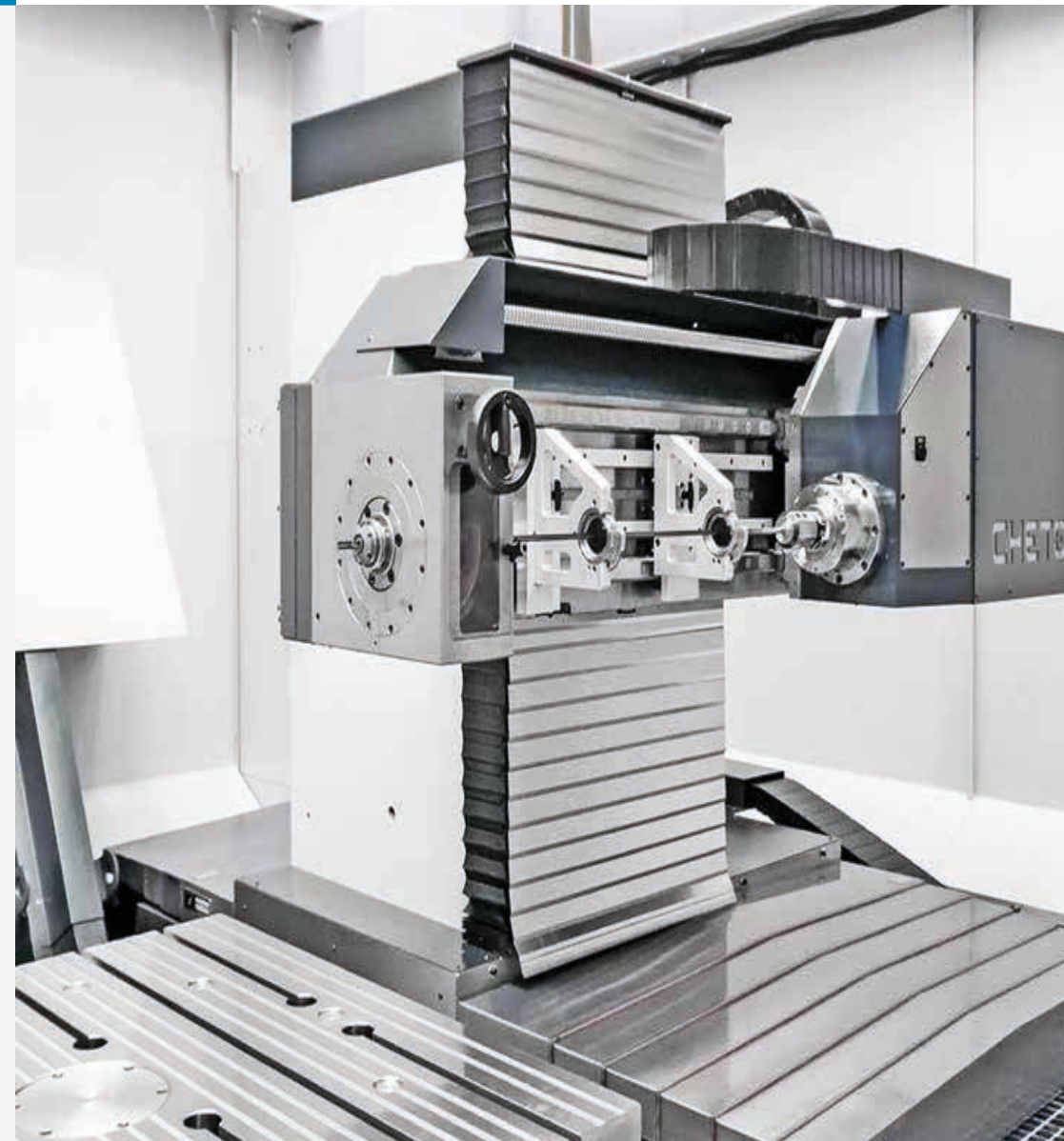

# PTT 2500

5 AXES

## Standard Equipment

- CNC FAGOR 8065
- Electronic handwheel
- Digital drives
- Nitrogen double counterweight
- Absolute linear encoders in axes X, Y and Z
- Absolute angular encoders in axis A and B
- Automatic chip conveyor
- Kinematics / RTCP
- Rigid tapping
- Quick change between drilling/milling
- Coolant tank with automatic filtering
- Submerged pumps for oil recirculation
- High pressure pump 80 bar, 100 l/min | 1,160 psi, 26.5 gal/min
- Telescopic covers in all axes (except drilling axis)
- Complete cover with doors, laminated glass windows and acrylic ceiling
- Linear roller guideways
- Table tilting -100°/+45°

## Optional Equipment

- CNC HEIDENHAIN TNC 640
- CNC SIEMENS SINUMERIK ONE
- Wise software system
- ATC up to 120 tools (up to 600 mm | 23.6 in tool length)
- ATC Gun drill up to 5 tools
- Table with zero clamping system
- Automatic curtain on load/unload door
- AC for electrical cabinet
- Y axis = 1500 mm | 59.1 in
- W axis = 2100 mm | 82.7 in
- Oil mix collector
- Electronic Touch Probe and Tool Preset Laser System
- Spindle gearbox
- Immersion chiller for oil/emulsion
- Pack Connectivity i4.0

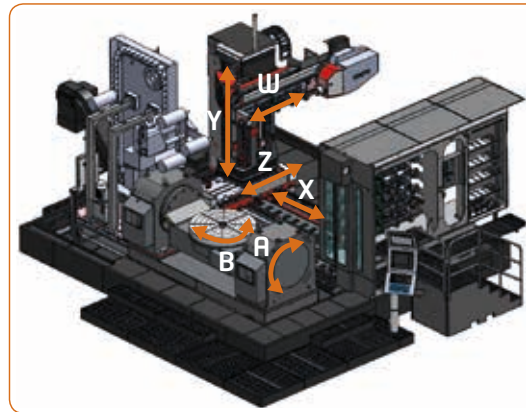

<sup>1</sup>GunDrill Automatic Tool Change

<sup>2</sup>Approximated values, it depends on the final machine configuration

(Subject to modifications without prior notice)





## Technical Data

## 2500

**CNC Axis**

W drilling one stroke	1700 mm	66.9 in
X longitudinal travel	2500 mm	98.4 in
Y vertical travel	1200 mm	47.2 in
Z cross travel	800 mm	31.5 in

**Drilling capacity**

Max. drilling stroke W+Z	1700+800 mm	66.9+31.5 in
Drilling capacity	ø5-40 mm	ø0.2-1.58 in

**Milling capacity**

Milling	400 cm <sup>3</sup> /min	24.4 in <sup>3</sup> /min
Rigid tapping	M32	
Helical threading	Standard	

**Spindle unit**

Spindle taper	ISO 50 DIN 69871A	
Speed	0-4500 rpm	
Power	15/22 kW	20/30 hp
Torque	191/287 Nm	141/212 ft-lbs

**Table**

Table size	ø1300 mm	ø51.2 in
Max. load in rotation	2,500/5,000 kg	5,512/11,023 lbs
Max. diameter in rotation	2200 mm	86.6 in

**Tilting Axis**

Max. feed	2 rpm	
Max. range	145° (-100-+45)	

**Rotary Axis**

Max. feed	5 rpm	
-----------	-------	--

**Layout dimensions**

Total weight	39 Ton	87,360 lbs
Total weight <sup>1</sup> GDATC	45 Ton	100,800 lbs
<sup>2</sup> Foot print (WxL)	7800x8500 mm	307.1x334.6 in



### Standard Equipment

- SIEMENS SINUMERIK ONE
- Digital drives
- External status led indication
- High-capacity roller linear guides in all axes
- Chip conveyor dedicated to BTA process
- Chip conveyor dedicated to Gundrill process

### Optional Equipment

- Tool monitoring
- Process documentation
- Collision detection
- Fire suppression system for oil tank
- Oil mix collector for drilling unit
- Chip treatment station
- Retractable system for probe
- Pack Connectivity i4.0

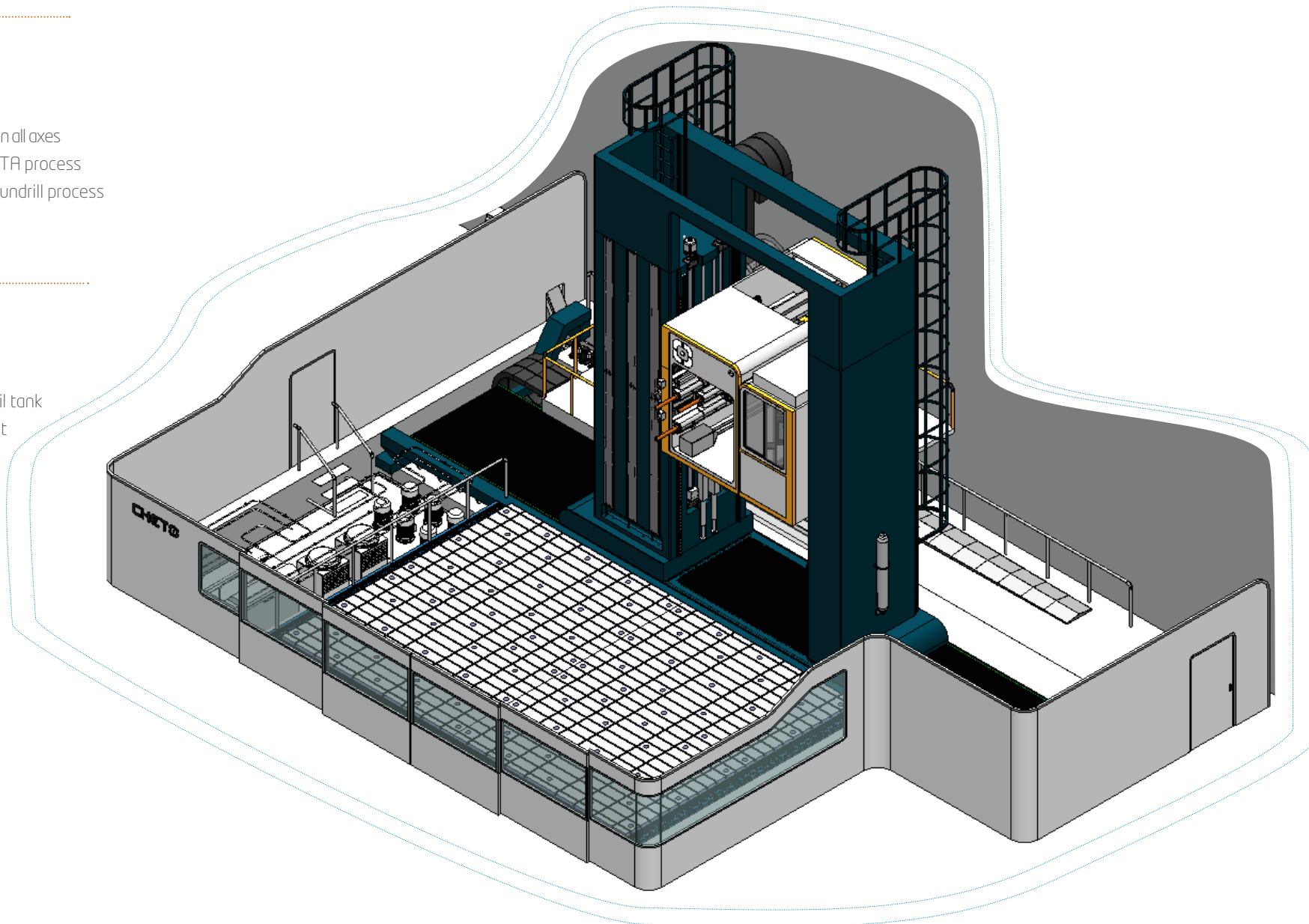

## Technical Data

	25 kW		37 kW	
<b>Drilling capacity</b>				
BTA System	8-32 mm	1.3 in	8-50.8 mm	2.0 in
Gun Drill System	8-32 mm	1.3 in	8-50.8 mm	2.0 in
<b>Movable column</b>				
X travel	3000-10000 mm	118.1-393.7 in	3000-10000 mm	118.1-393.7 in
<b>Rapid/Working feed</b>				
X axis	15 m/min-4 m/min		15 m/min-4 m/min	
Y axis	15 m/min-4 m/min		15 m/min-4 m/min	
Z axis	15 m/min-4 m/min		15 m/min-4 m/min	
<b>Vertical drilling unit</b>				
Y travel	3000-4500 mm	118.1-177.2 in	3000-4500 mm	118.1-177.2 in
<b>Drilling head</b>				
Number of drilling heads	1 to 5		1 to 5	
Drilling stroke (Z axis)	1300 mm	51.2 in	1300 mm	51.2 in
Pressure head travel (W axis)	650 mm	25.6 in	650 mm	25.6 in
<b>Moving heads (V1 and V2)</b>				
Distance from center head	200-400 mm	7.9-15.7 in	250-400 mm	9.8-15.7 in
<b>Spindles motors speed and power</b>				
Speed rotation (each spindle)	0-4500 rpm		0-4500 rpm	
Power (each spindle)	25 kW	34 hp	37 kW	50 hp
Max torque	272 Nm	201 ft-lbs	330 Nm	243 ft-lbs
<b>Layout dimensions</b>				
Total weight	170 Ton	380,800 lbs *	170 Ton	380,800 lbs *
Foot print (WxL)	12775x20285 mm	502.9x798.6 in *	12775x20285 mm	502.9x798.6 in *
<b>Machine power</b>				
Total power	200 kW	268 hp	236 kW	316 hp

\*Susceptible to change according to machine configuration.

(Subject to modifications without prior notice)



## Standard Equipment

- BTA or Gun Drill system
- Temperature of the oil and level of the tank monitoring
- Automatic chip conveyor
- Coolant tank with automatic filtering
- Pressure and flow monitoring of drilling fluid
- Easy determination of workpiece origin
- Remote diagnosis
- Clamping cones set
- NC tailstock
- Automatic doors

## Optional Equipment

- SIEMENS CONTROL
- X axis
- Tailstock
- Pack Connectivity i4.0

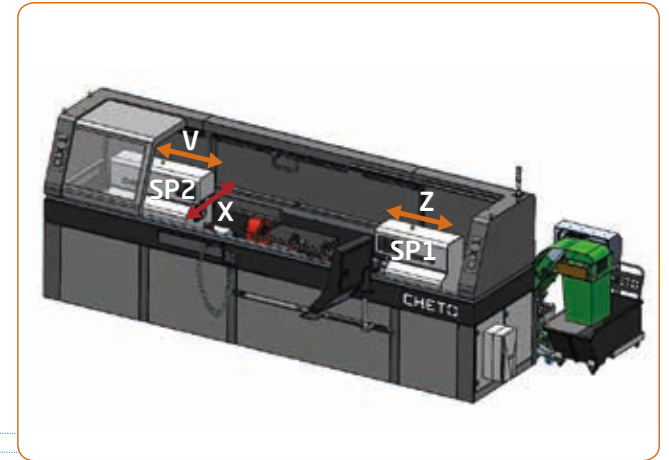

up to 3 AXES

INL deep hole drilling **BTA | GUNDRILL**

### Technical Data

	BTA*		GUNDRILL	
<b>Drilling capacity</b>				
Solid drill in steel	∅18-32 mm	∅0.7-1.3 in	∅18-55 mm	∅0.7-2.2 in
			∅5-25 mm	∅0.2-1.0 in
<b>Drilling unit</b>				
Number of spindles	1		1	1 to 6
Depth	150-3000 mm	5.9-118.1 in	150-3000 mm	5.9-118.1 in
<b>Control</b>				
Reference	BECKOFF		BECKOFF	BECKOFF
<b>Spindle</b>				
Max. speed spindle	0-2300 rpm		0-2300 rpm	0-6000 rpm
Power	25 kW	34 hp	37 kW	50 hp
Max. torque	272 Nm	201 ft-lbs	330 Nm	243 ft-lbs
Rapid feed	5000 mm/min		5000 mm/min	5000 mm/min
<b>Coolant system</b>				
Volume	3000 L		4000 L	1500 L
Pump capacity	160 l/min		160-280 l/min	100 l/min
Max. coolant pressure	50 bar		50-30 bar	80 bar
<b>Layout dimensions</b>	Dimensions of the machine according to the depth			

\*Others under request

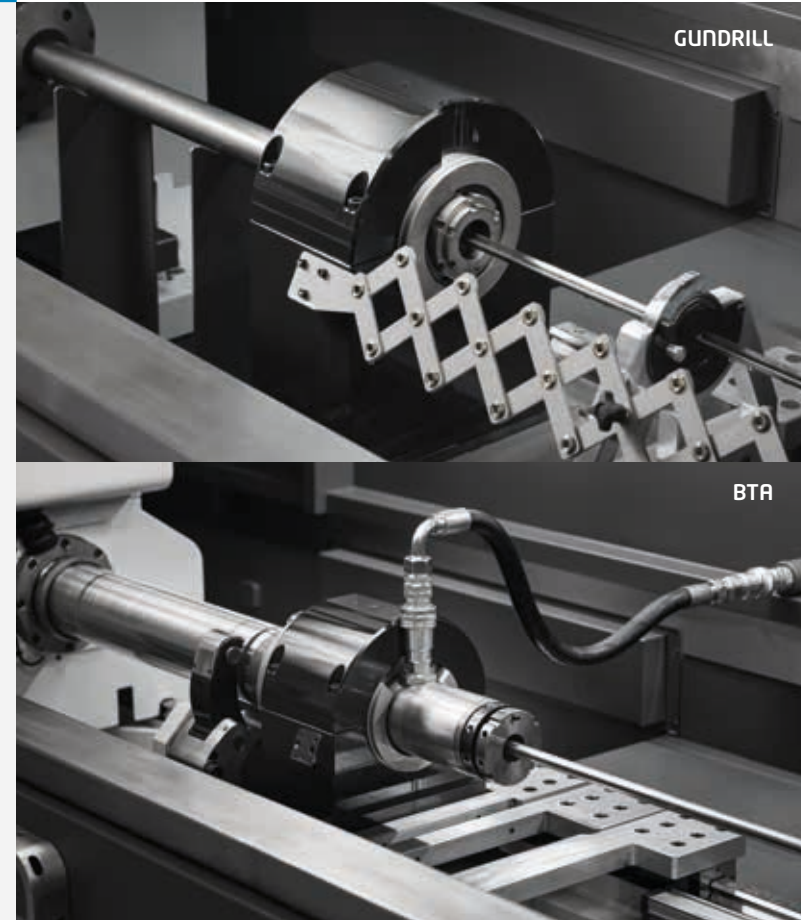

(Subject to modifications without prior notice)



# FOOT PRINT CHETO MACHINES

## IXN1000

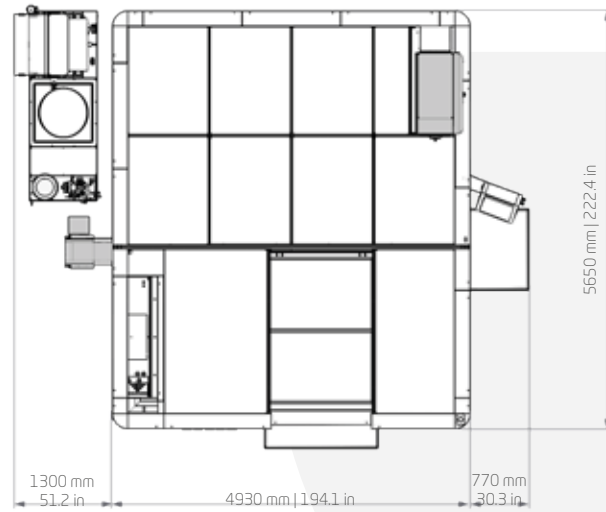
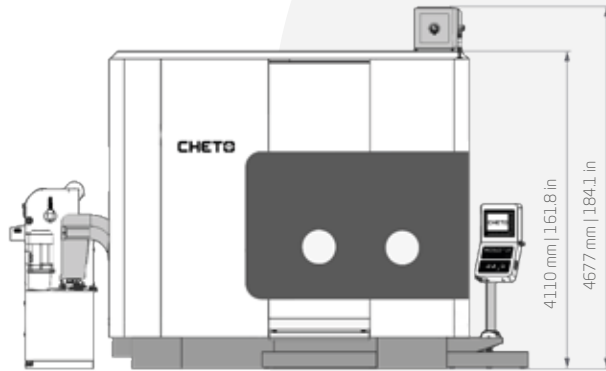

## IXN2000

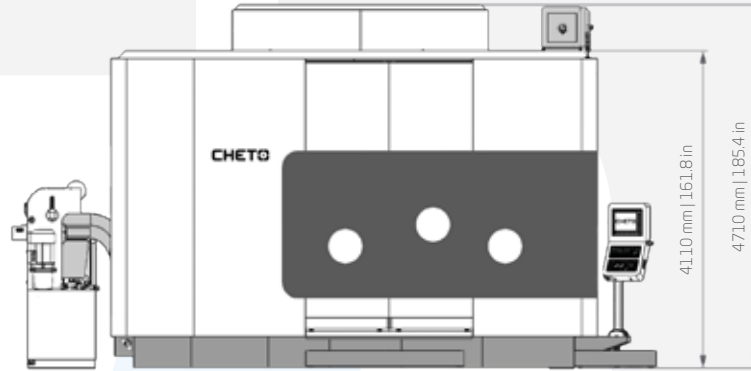

## IXN3000

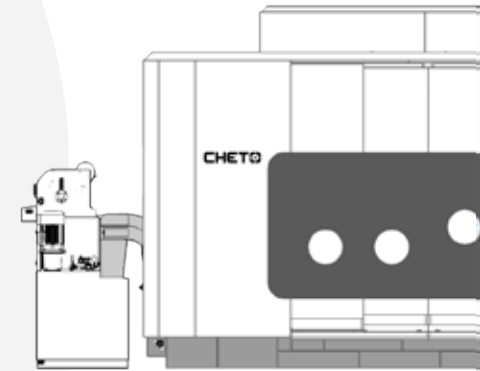

# FOOT PRINT CHETO MACHINES

## SiC650

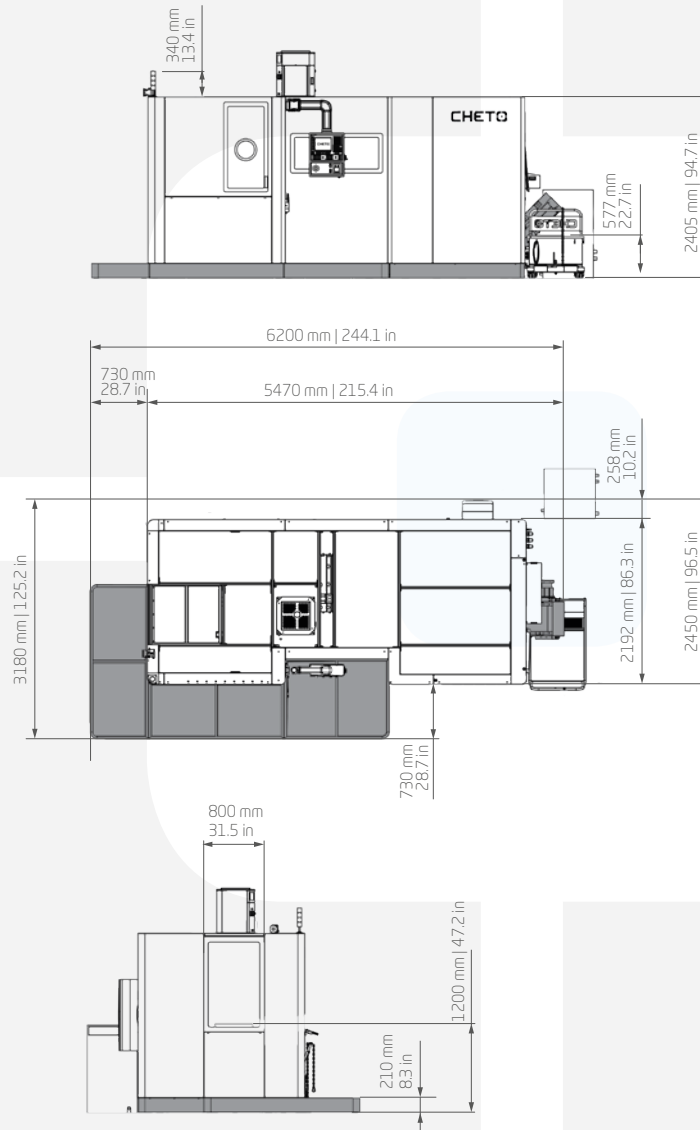
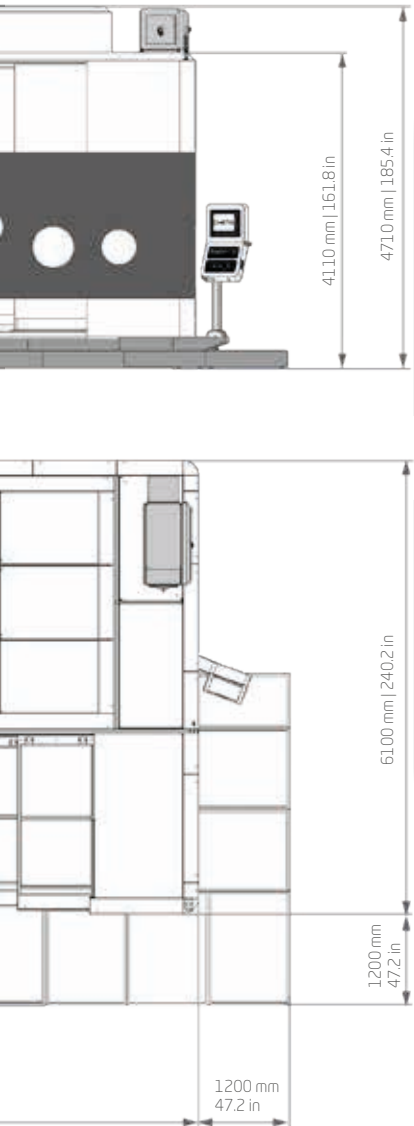

## SiC1000 HD

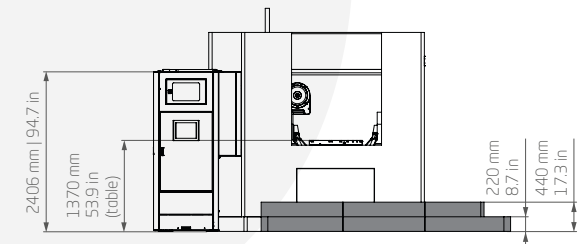
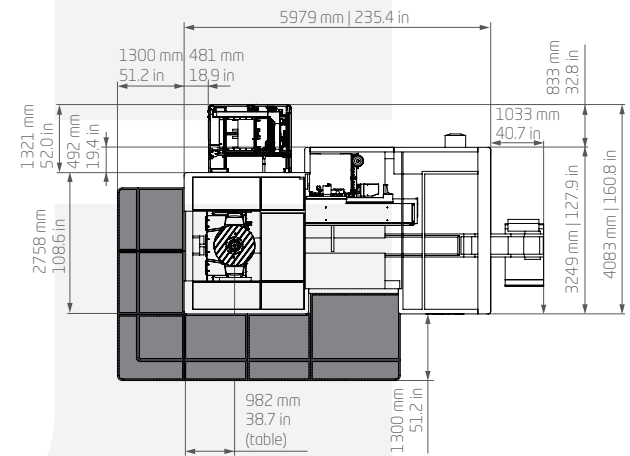

Registered Design

Subject to technical change without notice

# DESIGN AND STRUCTURE

## Internal development

- User-friendly  
Fitting the customer needs

## FEM

- Finite Element Method

## Structure

- The best performance with all structure components in cast iron

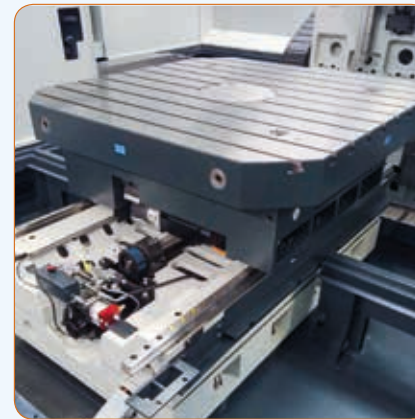

Cast iron structure

# WISE SOFTWARE SYSTEM

PATENT NUMBER 3535627

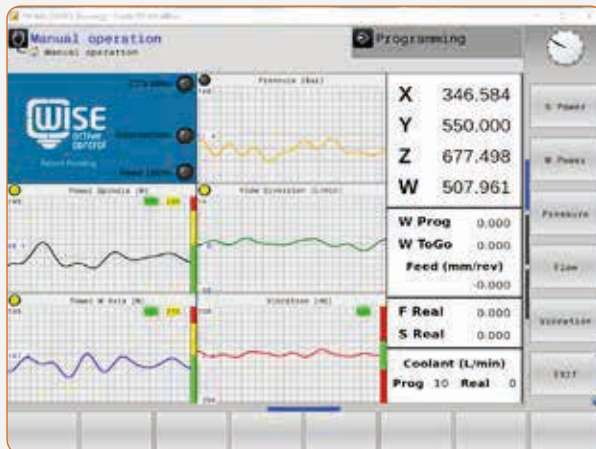

Wise software system is an application developed by **Cheto Corporation** for deep hole drilling machines whose main objective is to adapt machining parameters on-line to optimize the material cutting process and tool lifetime without the presence of an alert operator and drilling expert.

The diversity of operations, the lack of raw materials homogeneity, the deficient parameter settings, and intersection holes often lead to the reduction of the tool lifetime.

As hole intersections are a constant matter on mold making, and considering the difficulty of these operations, it's common to have problems on final results as unexpected hole drifts, premature tool wear or tool break.

All these effects may lead to costs that are never covered by a budget, and are later called extraordinary costs of nonconformance.

## Process Control

- The system continuously monitors machine's critical variables of the working process (oil pressure, oil flow, vibrations, power consumption, etc.), and automatically adjusts the drilling parameters in order to keep a stable and continuous process.

## Intersections Control

- The system automatically detects intersections in the process and sets the parameters accordingly to keep the quality of the operation and to protect the tool lifetime.





## HEIDENHAIN

[www.heidenhain.com](http://www.heidenhain.com)

### TNC 640 - The numeric control to mill and drill

The HEIDENHAIN TNC 640 is a high-end numeric control for deep hole drilling and combined machining centers up to 18 axis. The TNC 640 offers the user numerous workshop-oriented functions and many advantages:

- Optimized motion control
- High machining speeds
- Outstanding contour accuracy
- Short processing times
- Fully digital structure and integrated digital drive control
- Clear and dialog-assisted user interface



## FAGOR

FAGOR AUTOMATION

[www.fagorautomation.com](http://www.fagorautomation.com)

### Control system FAGOR with most advanced technology

- Digital drives, fiber-optics communication
- Feed hand wheel
- Easy operation based on pop-up menus
- Standard and **CHETO** conversational cycles
- Linear/angular absolute encoders
- PC simulator available
- Next job programming/simulation while executing other job
- Friendly operator safety
- Maintenance tools for easy failure diagnosis
- Easy inclined plane functions
- Advanced tool inspection



## SIEMENS

[www.siemens.com](http://www.siemens.com)

### Control system SIEMENS with most advanced technology

- Powerful technology functions
- Flexible CNC programming
- Easy detection of operational errors
- Prevention of collisions before they occur
- Detection on underloads and overloads during the operation
- Easy to operate
- Intuitive user interface
- Quick machine setup
- Precise freeform surfaces
- Easy inclined plane functions
- Advanced tool inspection

# LINEAR GUIDANCE SYSTEMS



## Screws

- Rectified
- High precision
- Adapted to **i4.0**

## IXN/PWN/PTT models

- Screw  $\varnothing 40$  mm |  $\varnothing 1.58$  in (axis W)
- Screw  $\varnothing 63$  mm |  $\varnothing 2.48$  in (axis X, Z)
- Screw  $\varnothing 50$  mm |  $\varnothing 1.97$  in (axis Y)

## CCN model

- Screw  $\varnothing 40$  mm |  $\varnothing 1.58$  in (axis X, Y, Z and W)

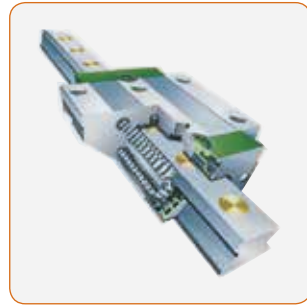

## Linear guides

- High precision
- High pre-load
- Adapted to **i4.0**

## IXN/PWN models

- 3 slides by guide (axis X, Y, Z, W)

## CCN model

- 3 slides by guide (axis X, Z)
- 2 slides by guide (axis Y, W)

## PTT models

- 3 slides by guide (axis X, Y, Z, W)



## Versatility

- Quick change between drilling and milling



## Deep hole drilling accessories

- Whip guides



- Guide bushes



- Tool holder



- Tool extender



- Steady rests



- Pull stud



- Gundrill grinder



**CHETO**



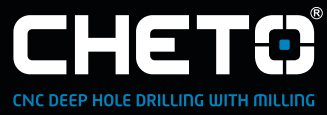

**CHETOCORPORATION, S.A.**

Área de Acolhimento Empresarial  
UI-Loureiro, Lotes 13-21  
3720-070 Loureiro, Oliveira de Azeméis  
Portugal

GPS: 40°48'00,5"N | 8°30'35,3"W

T. + 351 256 247 970

[www.cheto.eu](http://www.cheto.eu)

[info@cheto.eu](mailto:info@cheto.eu)

